

Strutture

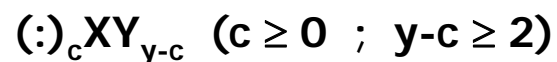

I) *lineare* se  $y = 2$  e  $c = 0$

Esempi:  $\text{BeH}_2$  (iduroruro di berillio) e  $\text{CO}_2$  (diossido di carbonio);

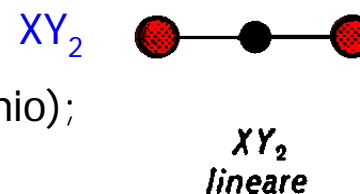

II) *a) triponale piana* se  $y = 3$  e  $c = 0$

Esempi:  $\text{BF}_3$  (trifluoruro di boro) ed  $\text{SO}_3$  (triossido di zolfo);

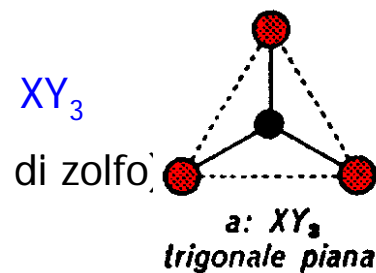

*b) angolare* se  $y = 2$  e  $c = 1$

Esempi:  $\text{SO}_2$  (diossido di zolfo) ed  $\text{NO}_2^-$  (ione nitrito);

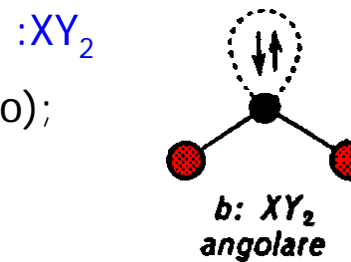

III)

a) *tetraedrica* se  $y = 4$  e  $c = 0$



Esempi:  $CH_4$  (metano) ed  $SiF_4$  (tetrafluoruro di silicio);

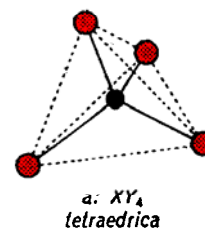

b) *piramidale trigonale* se  $y = 4$  e  $c = 1$



Esempi:  $NH_3$  (ammoniaca) e  $PCl_3$  (tricloruro di fosforo);

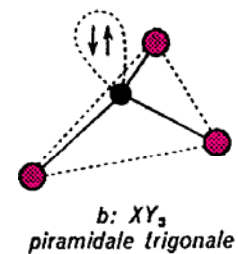

c) *a forma di V* se  $y = 4$  e  $c = 2$

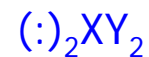

Esempi:  $OH_2$  (acqua) ed  $SH_2$  (acido solfidrico);

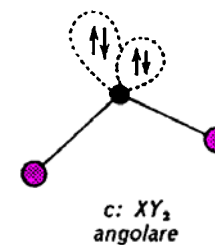

IV)

a) *bipiramidale trigonale* se  $y = 5$  e  $c = 0$

Esempi:  $\text{PCl}_5$  (pentacloruro di fosforo)

ed  $\text{AsF}_5$  (pentacloruro di arsenico)

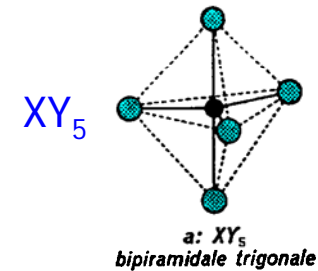

b) *tetraedrica irregolare* se  $y = 5$  e  $c = 1$

Esempi:  $\text{SF}_4$  (Tetrafloruro di zolfo)

ed  $\text{SeF}_4$  tetrafloruro di selenio

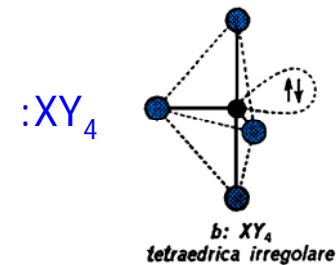

c) *piana a forma di T* se  $y = 5$  e  $c = 2$

Esempi:  $\text{ClF}_3$  (trifloruro di cloro)

e  $\text{BrF}_3$  (trifloruro di bromo)

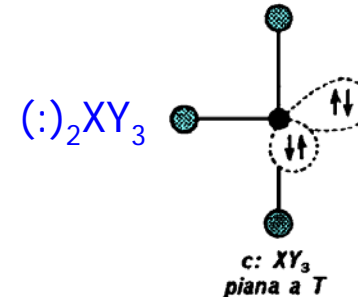

d) *lineare* se  $Y = 5$  e  $c = 3$

Esempi:  $\text{BrCl}_2^-$  (ione diclorobromato) ed  $\text{ICl}_2^-$  (dicloroiodato)

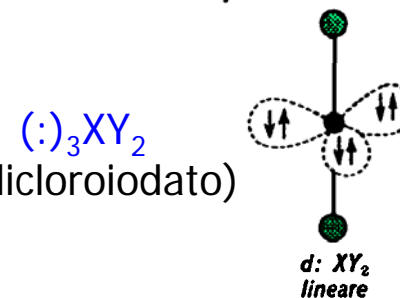

V)

a) *ottaedrica* se  $y = 6$  e  $c = 0$

Esempi:  $\text{SF}_6$  (esafluoruro di zolfo) e  $\text{PF}_6^-$  (ione esafluorofosfato);

$\text{XY}_6$

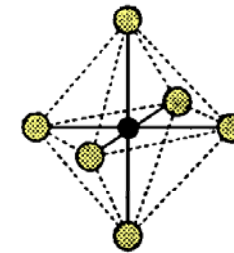

a:  $\text{XY}_6$   
*ottaedrica*

b) *piramidale tetragonale* se  $Y = 6$  e  $c = 1$

Esempi  $\text{BrF}_5$  (pentafluoruro di bromo)  
e  $\text{SbF}_5^-$  (ione pentafluoroantimoniato)

$:\text{XY}_5$

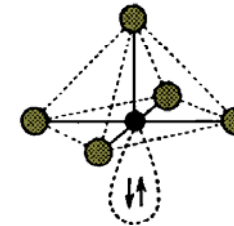

b:  $\text{XY}_5$   
*piramidale tetragonale*

c) *quadrata piana* se  $Y = 6$  e  $c = 2$

Esempi  $\text{BrF}_4^-$  (ione tetrafluorobromato)  
e  $\text{ICl}_4^-$  (ione tetracloroiodato)

$(:)_2\text{XY}_4$

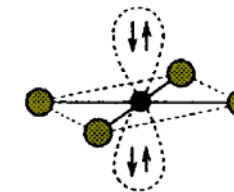

c:  $\text{XY}_4$   
*quadrata piana*



$XY_2$   
*lineare*

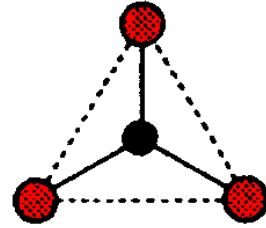

a:  $XY_3$   
*trigonale piana*

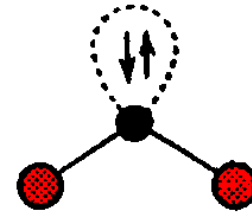

b:  $XY_2$   
*angolare*

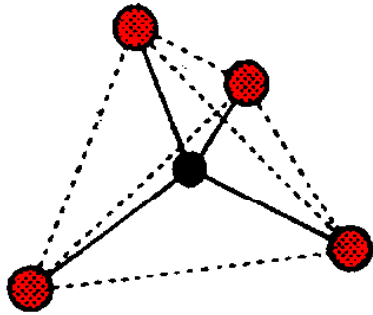

a:  $XY_4$   
*tetraedrica*

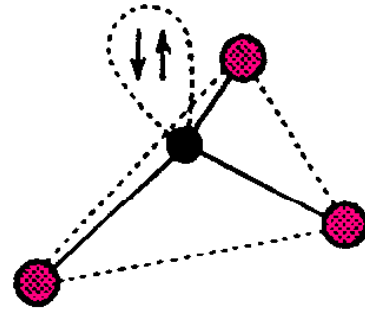

b:  $XY_3$   
*piramidale trigonale*

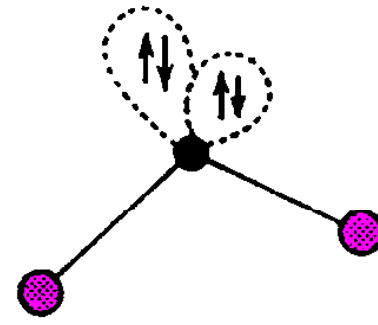

c:  $XY_2$   
*angolare*

---

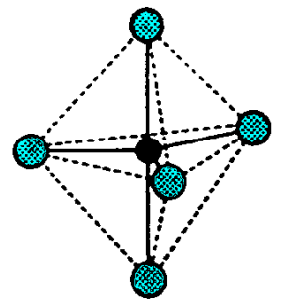

a:  $XY_5$   
bipiramidale trigonale

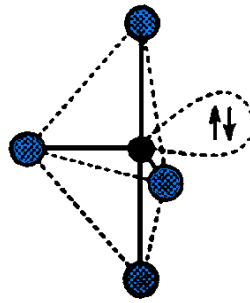

b:  $XY_4$   
tetraedrica irregolare

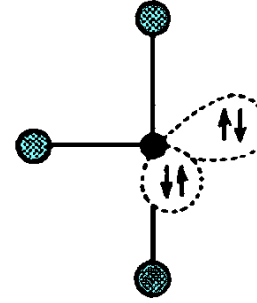

c:  $XY_3$   
piana a T

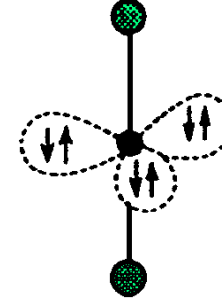

d:  $XY_2$   
lineare

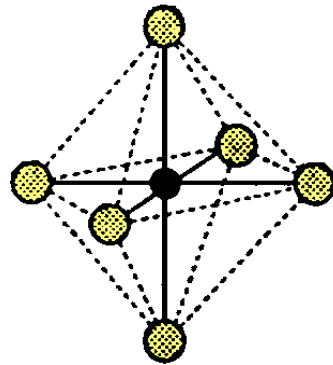

a:  $XY_6$   
ottaedrica

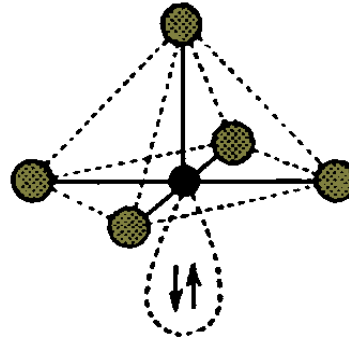

b:  $XY_5$   
piramidale tetragonale

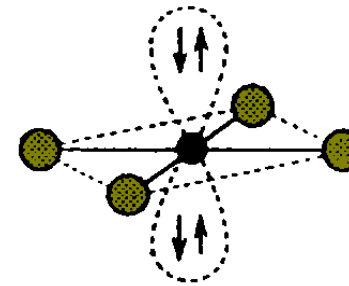

c:  $XY_4$   
quadrata piana

II a) molecole con l'atomo centrale ibridizzato  $sp^2$ ,  
a geometria trigonale piana

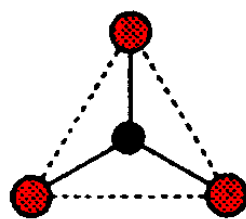

a:  $XY_3$   
trigonale piana

$BO_3^{-3}$  (ione ortoborato o borato)

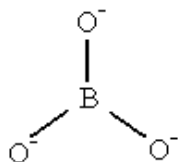

$BF_3$  (trifloruro di boro)

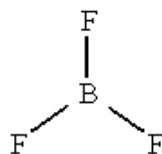

$CO_3^{2-}$  (ione carbonato)

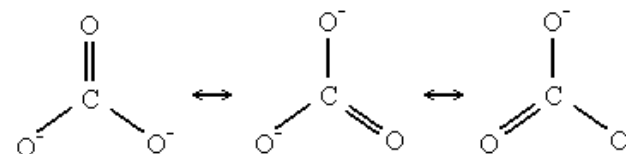

$NO_3^-$  (ione nitrato)

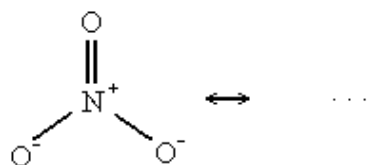

$SO_3$  (triossido di zolfo)

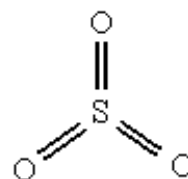



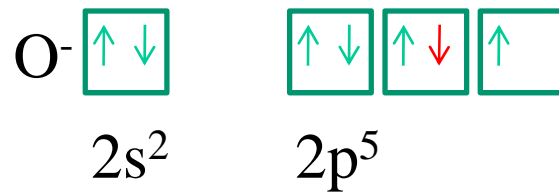
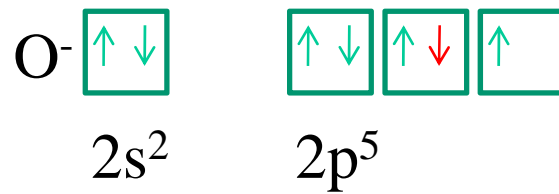
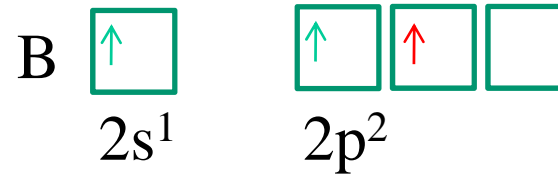
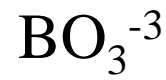
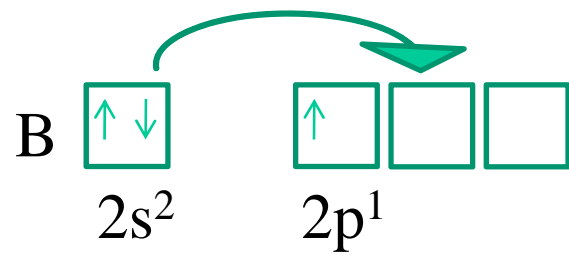

$$y - c = 3$$

$$y = 3 + c$$

$$c = 0$$

$$y = 3 \longrightarrow sp^2$$

Triangolare piana

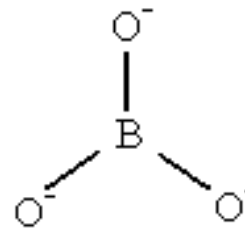
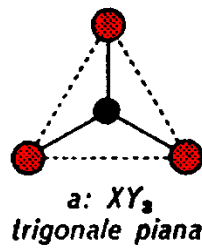

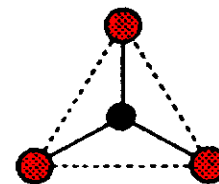
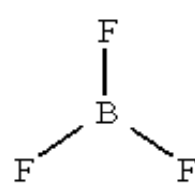
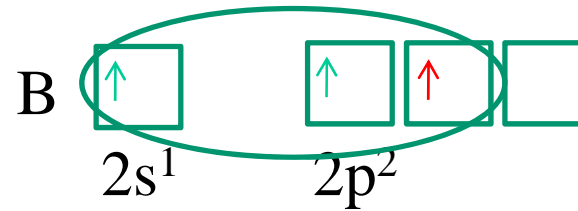
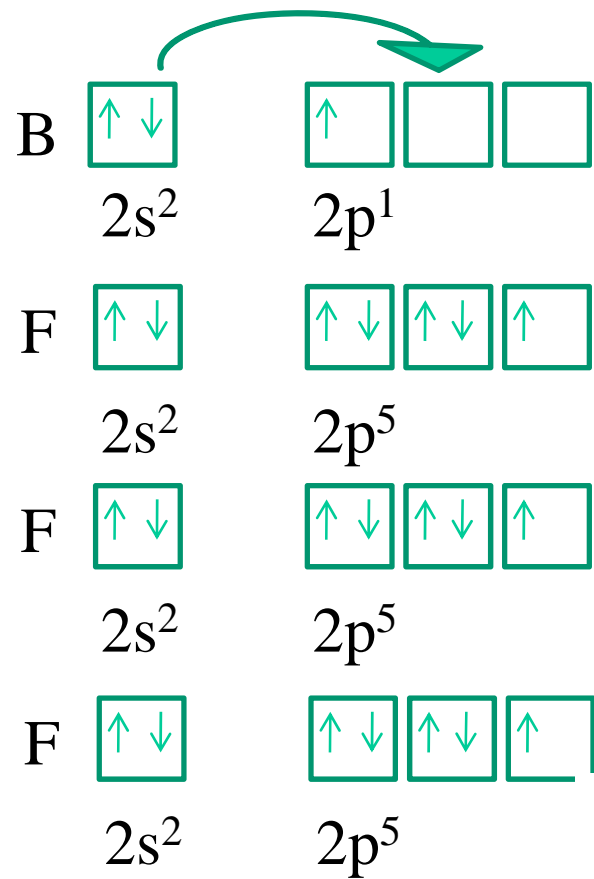

$a: XY_3$   
trigonale piana

$y-c=3$

$c=0$

$y=3 \longrightarrow sp^2$

Triangolare piana

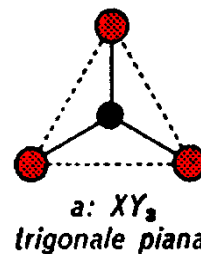
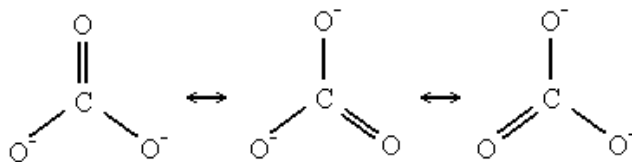
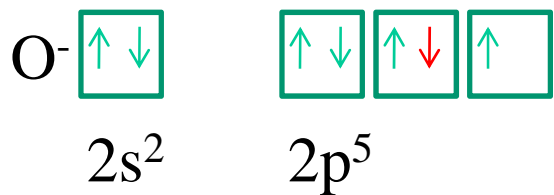
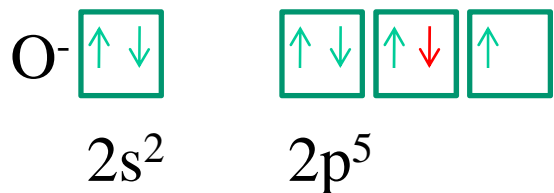
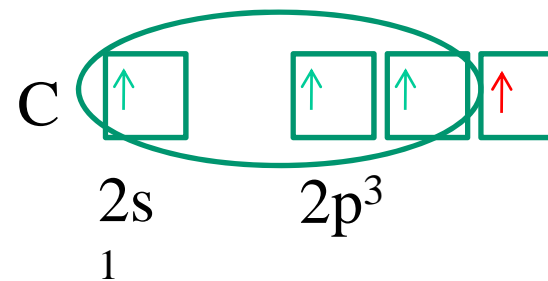
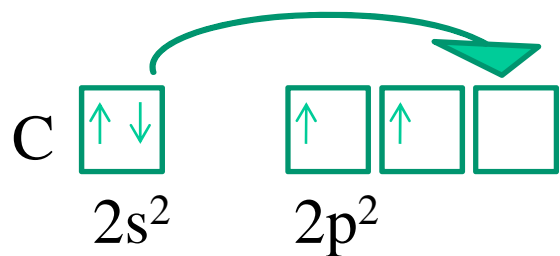

$y - c = 3$

$c = 0$

$y = 3 \longrightarrow sp^2$

Triangolare piana

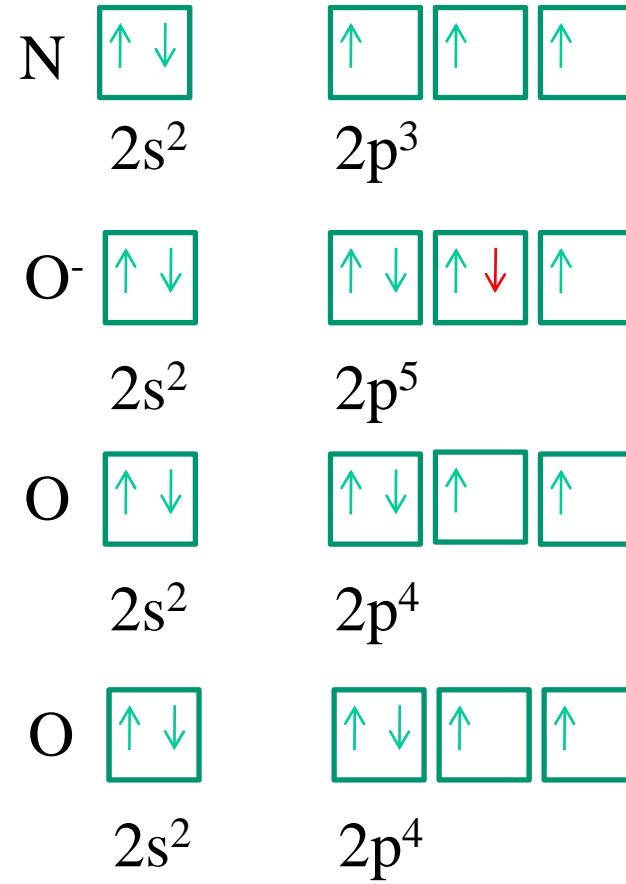

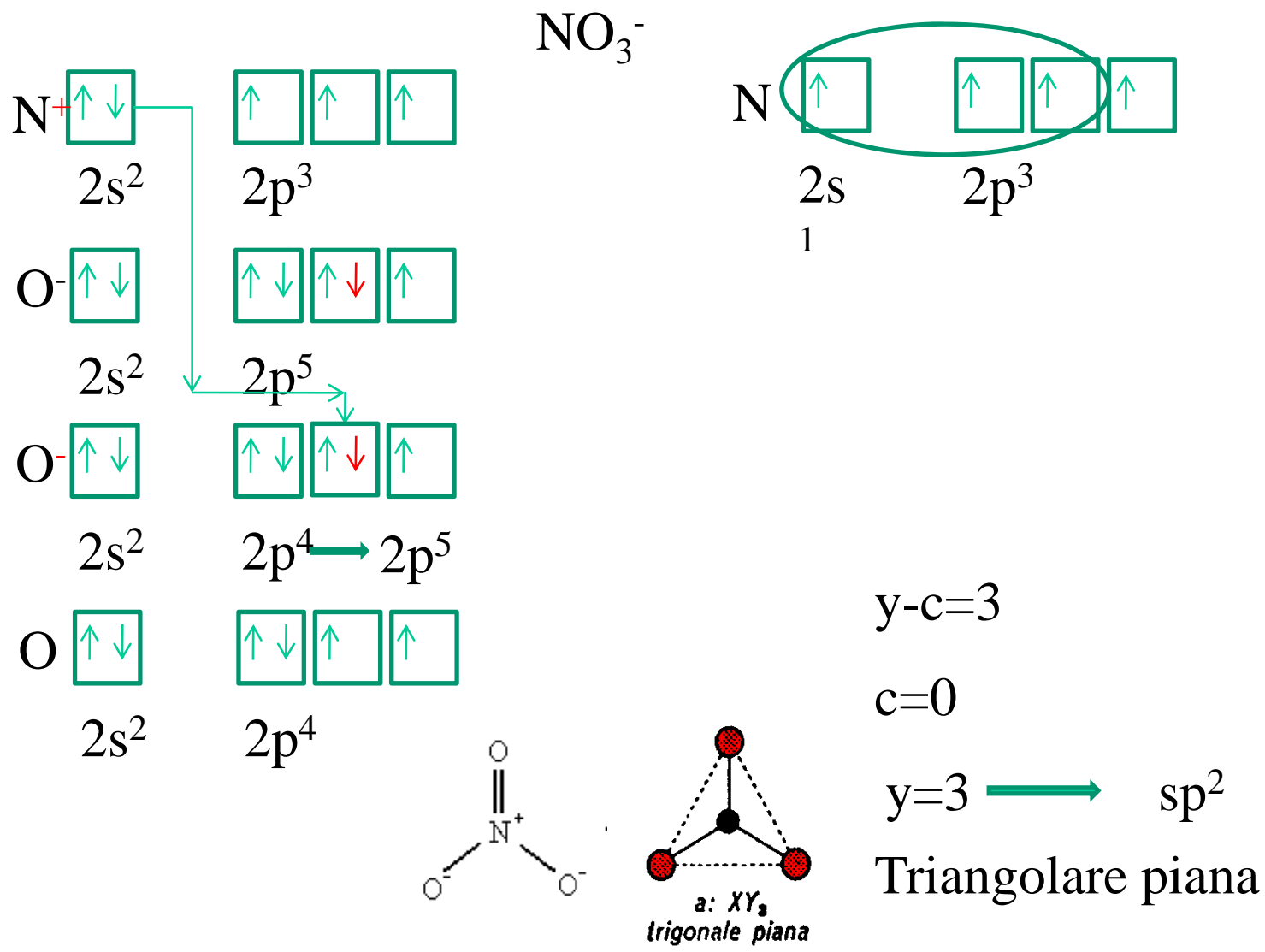

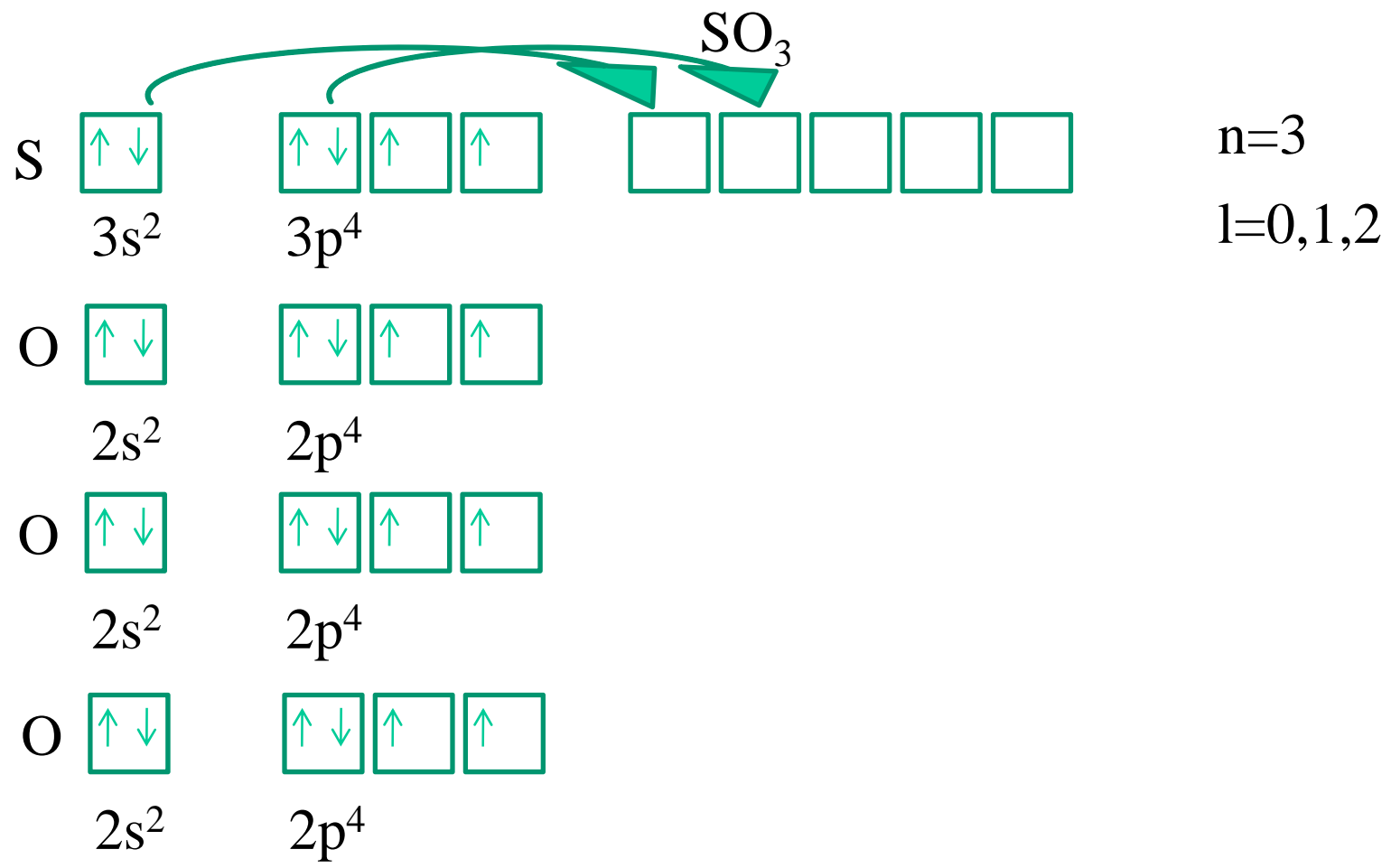

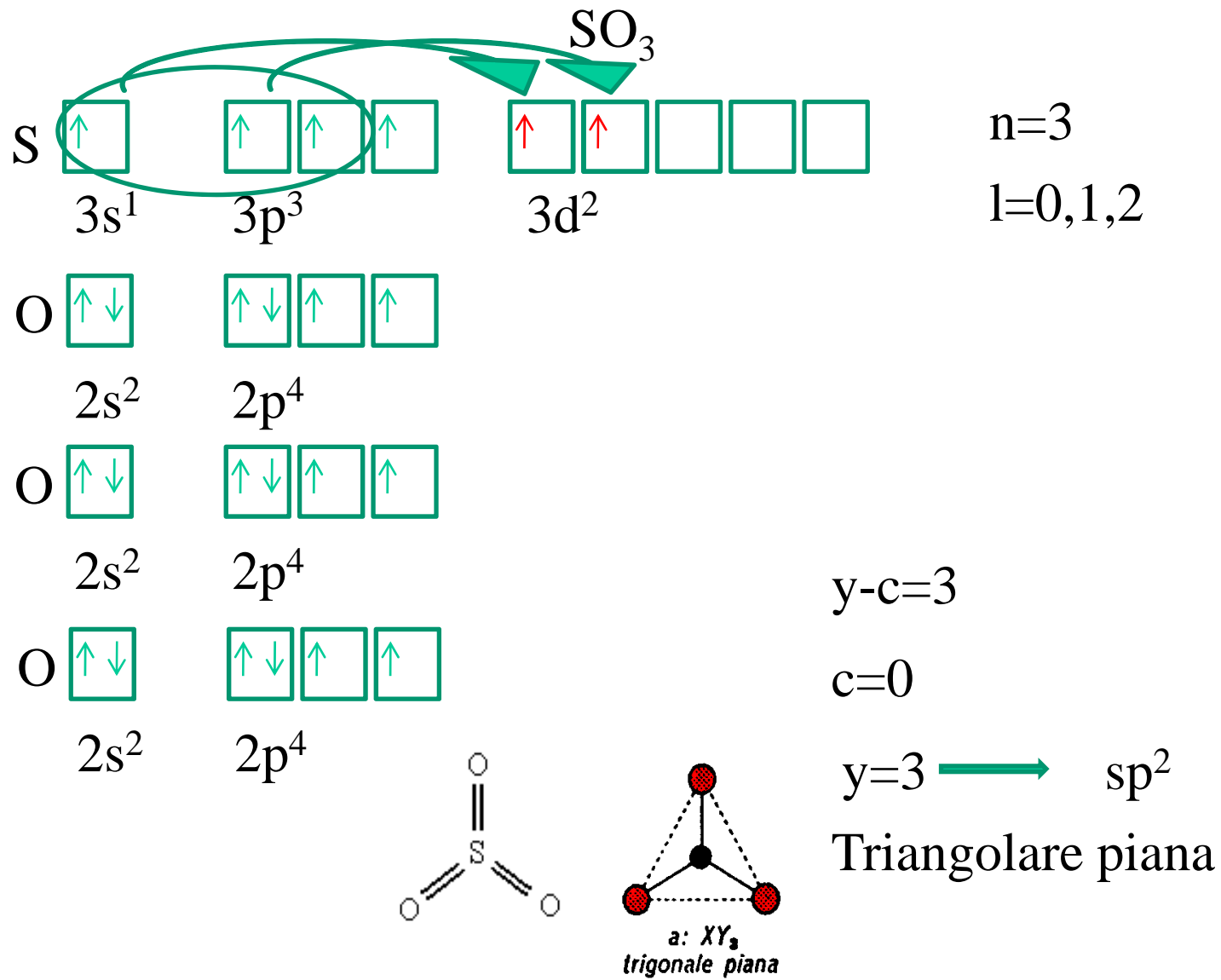

b) molecole con l'atomo centrale ibridizzato  $sp^2$ ,  
a geometria angolare

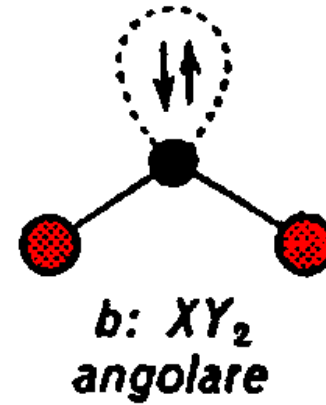
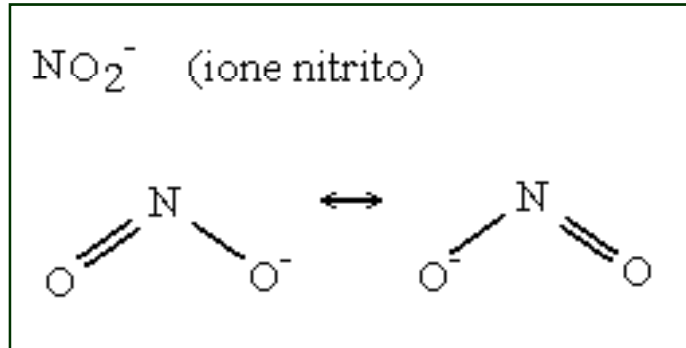

$\text{SO}_2$  (diossido di zolfo)



$\text{O}_3$  (ozono)

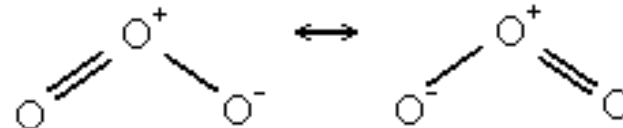



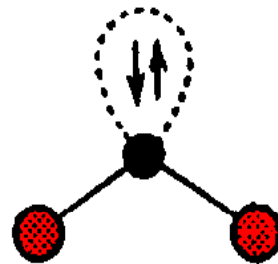
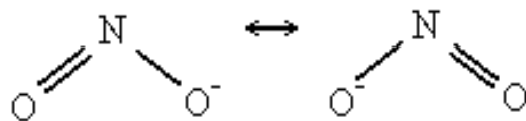
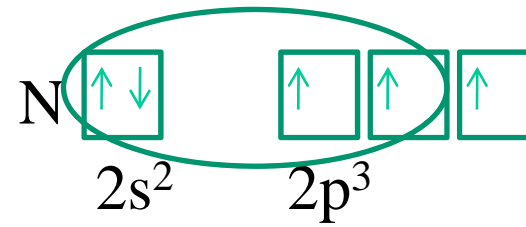
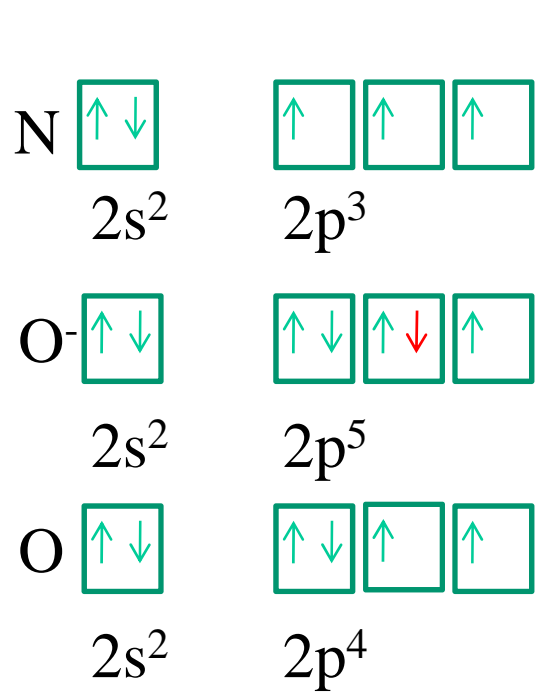

**$b: XY_2$   
angolare**

$y-c=2$

$c=1$

$y=3 \longrightarrow sp^2$

angolare piana

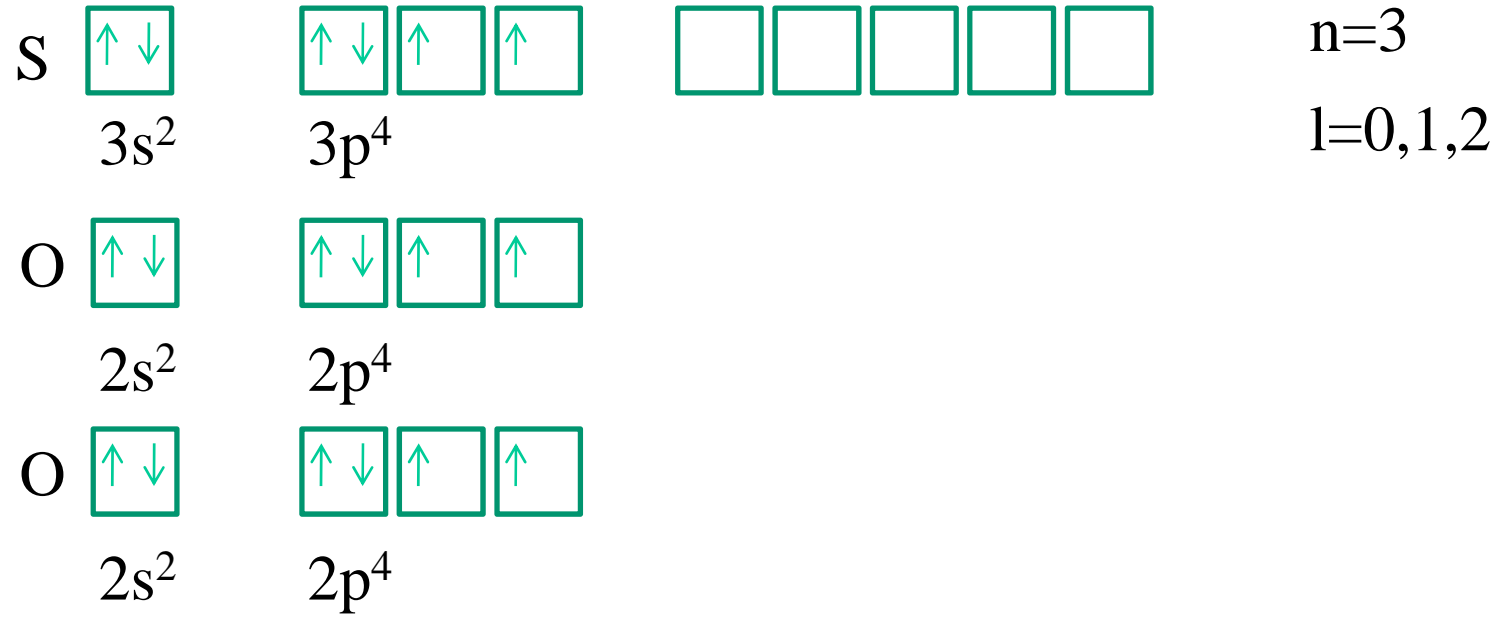

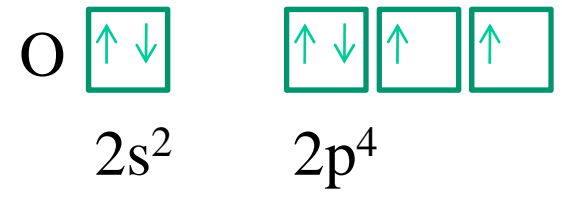
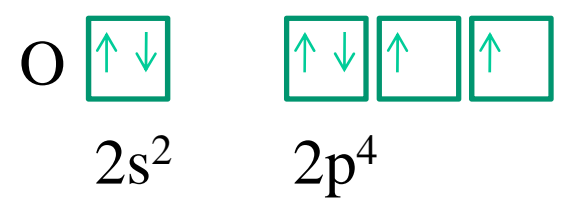
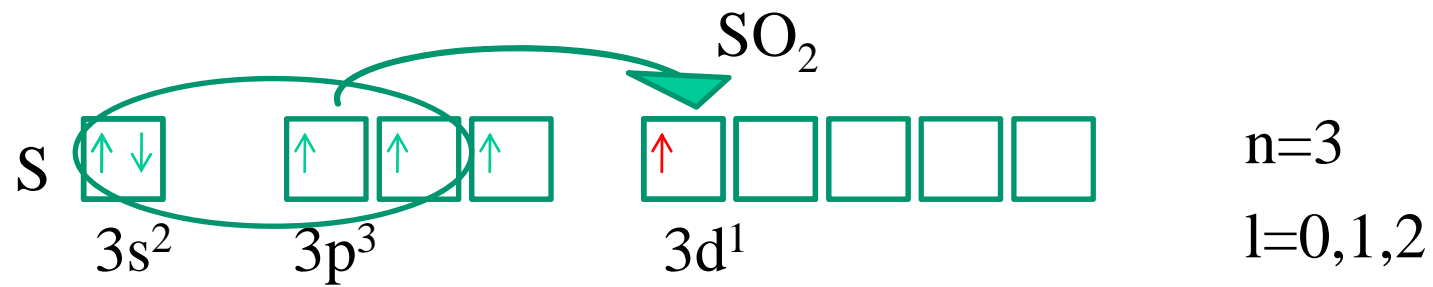

y-c=2  
 c=1  
 y=3 → sp<sup>2</sup>  
 angolare piana

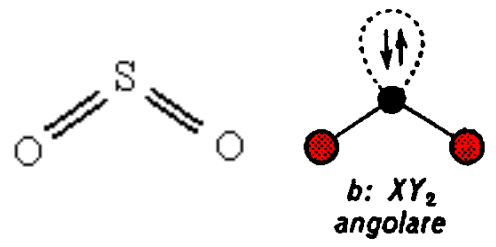

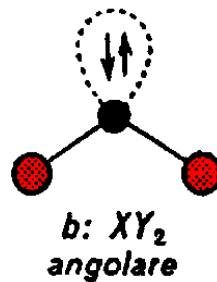
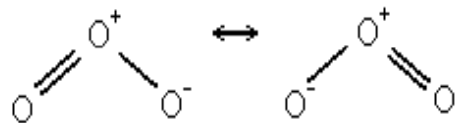
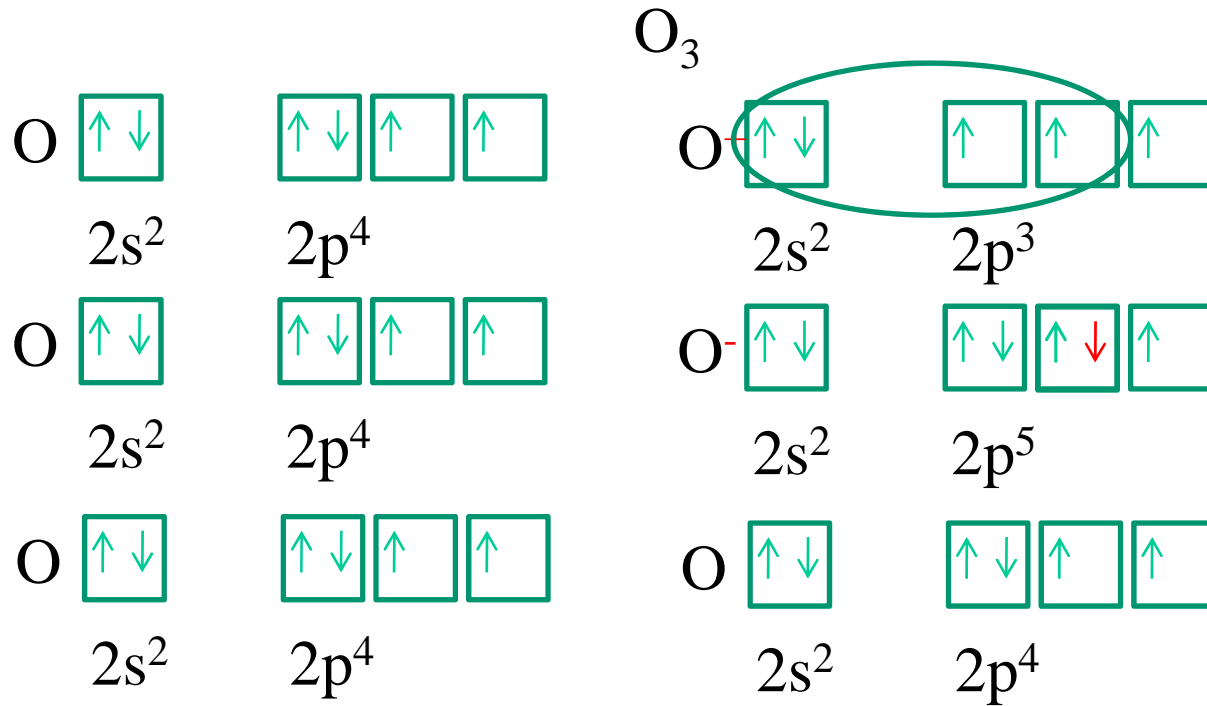

$$y - c = 2$$

$$c = 1$$

$$y = 3 \longrightarrow sp^2$$

angolare piana

III a) molecole con l'atomo centrale ibridizzato  $sp^3$ ,  
 a geometria **tetraedrica**

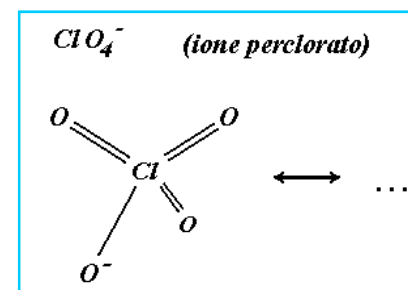
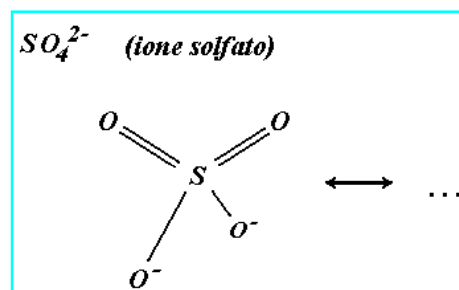
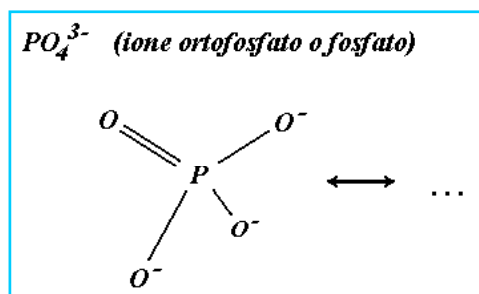
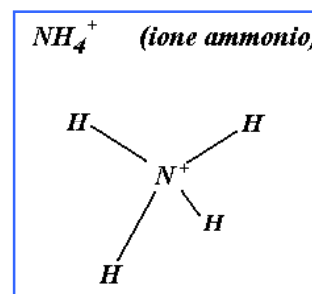
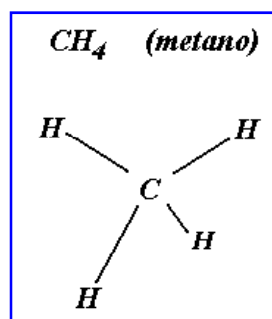
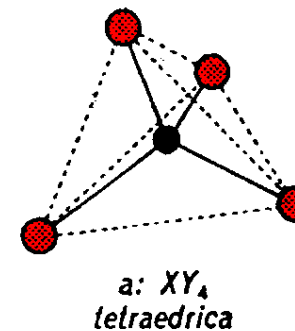
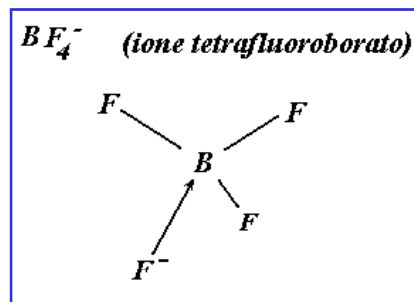
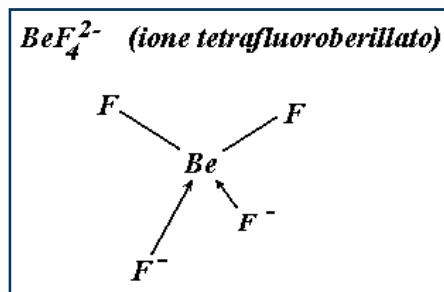

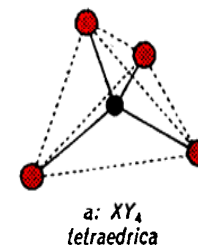
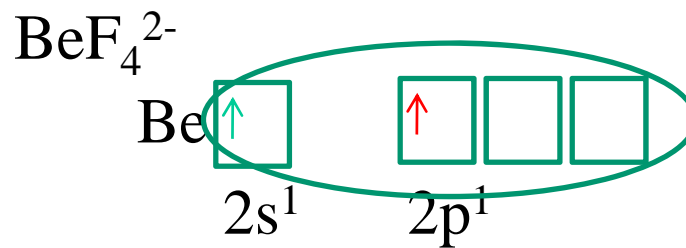
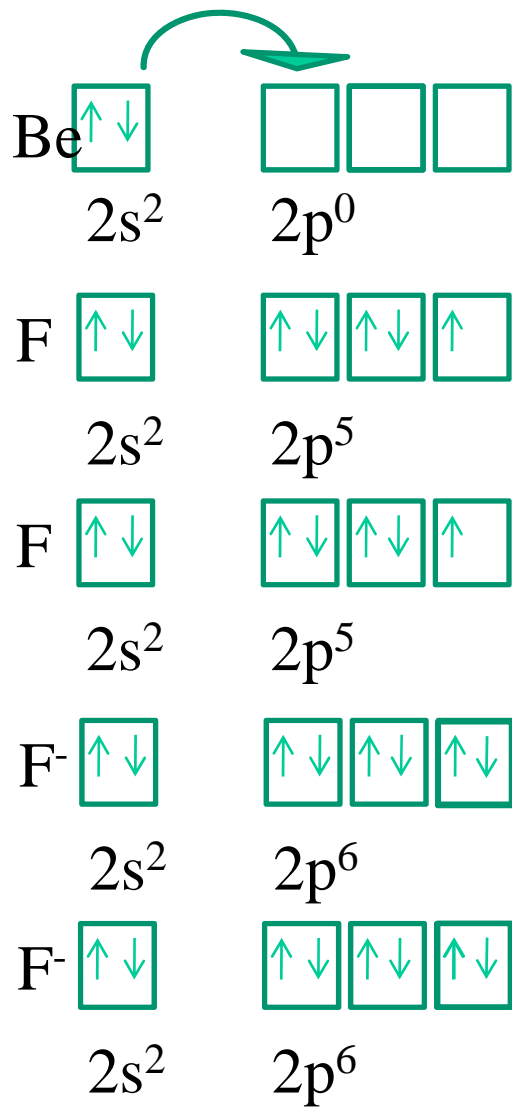

$$y - c = 4$$

$$c = 0$$

$$y = 4 \longrightarrow sp^3$$

tetraedrica

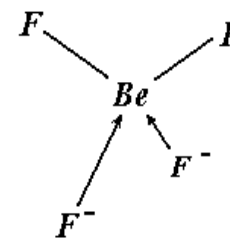

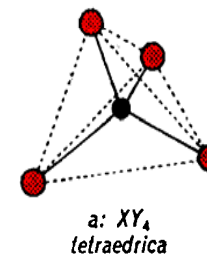
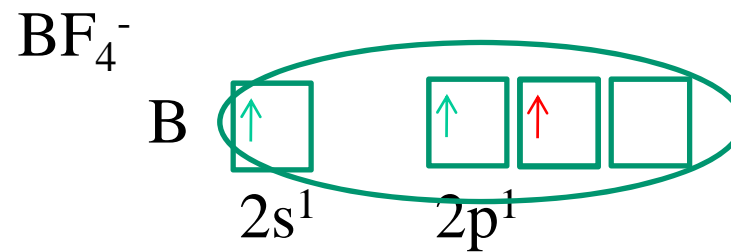
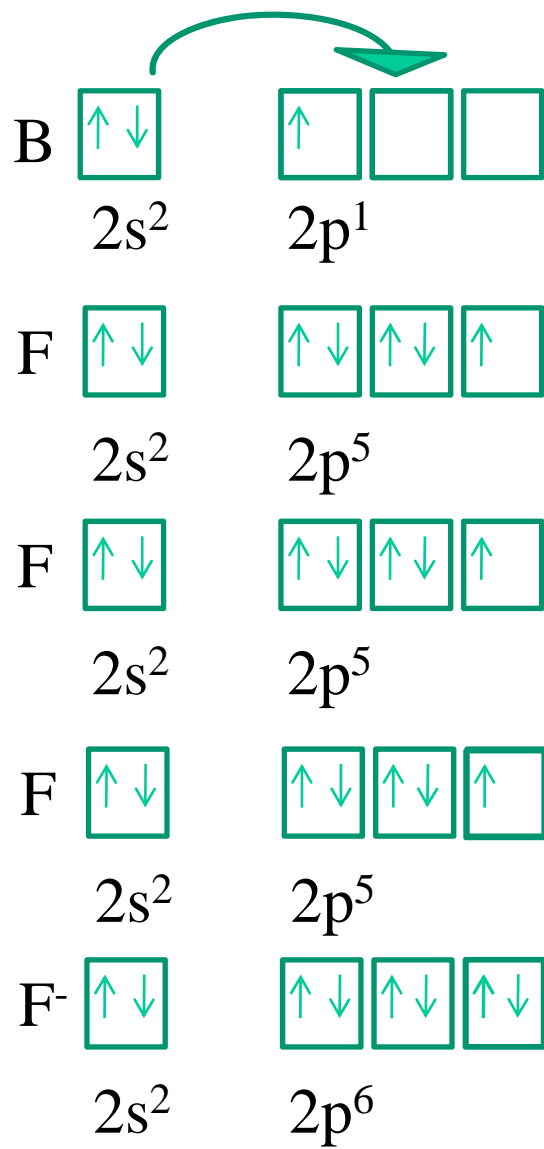

$$y - c = 4$$

$$c = 0$$

$$y = 4 \longrightarrow sp^3$$

tetraedrica

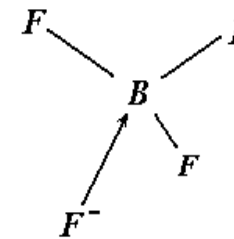

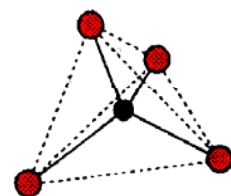
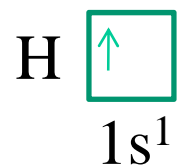
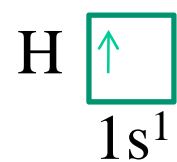
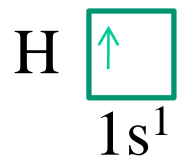
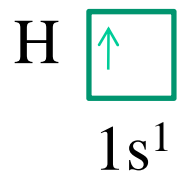
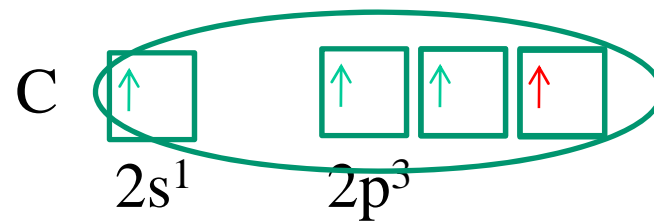
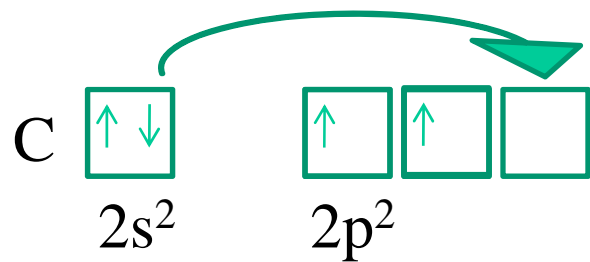

a:  $\text{XY}_4$   
*tetraedrica*

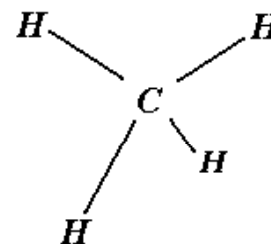

$y - c - 4$

$c = 0$

$y = 4 \longrightarrow sp^3$

tetraedrica



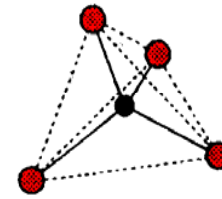
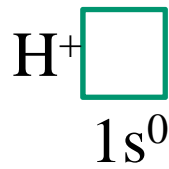
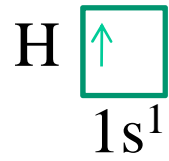
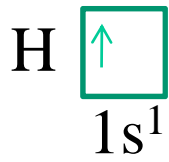
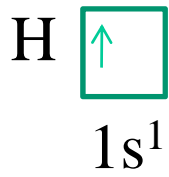
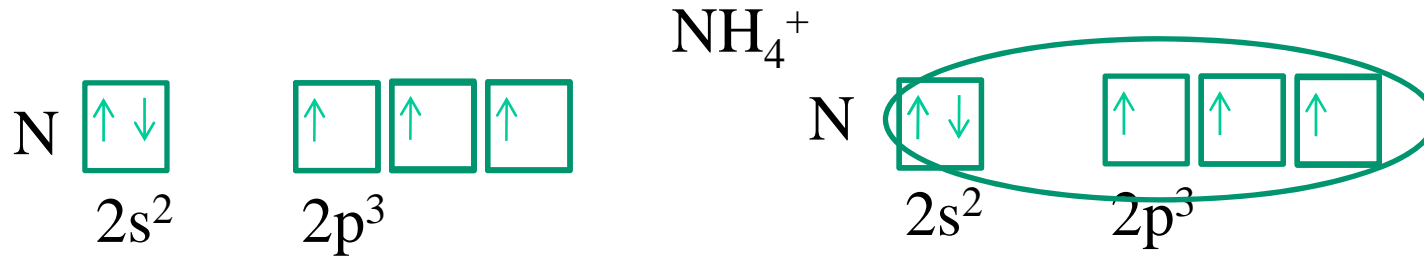

a:  $XY_4$   
tetraedrica

$y - c = 4$

$c = 0$



tetraedrica

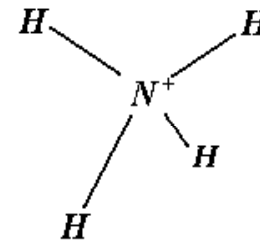

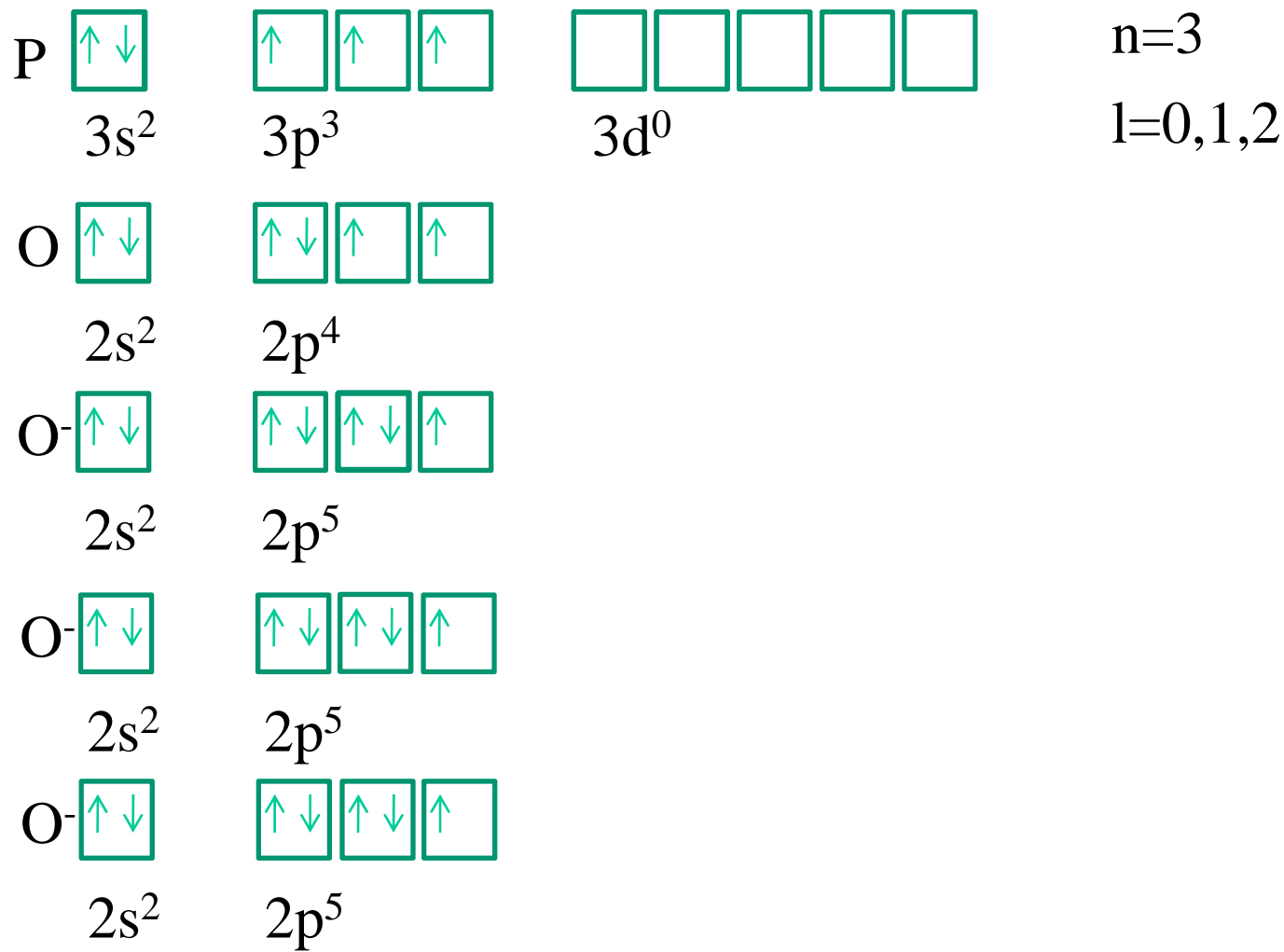

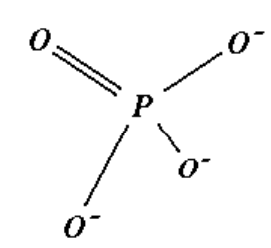
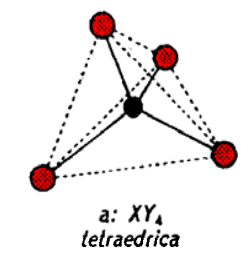
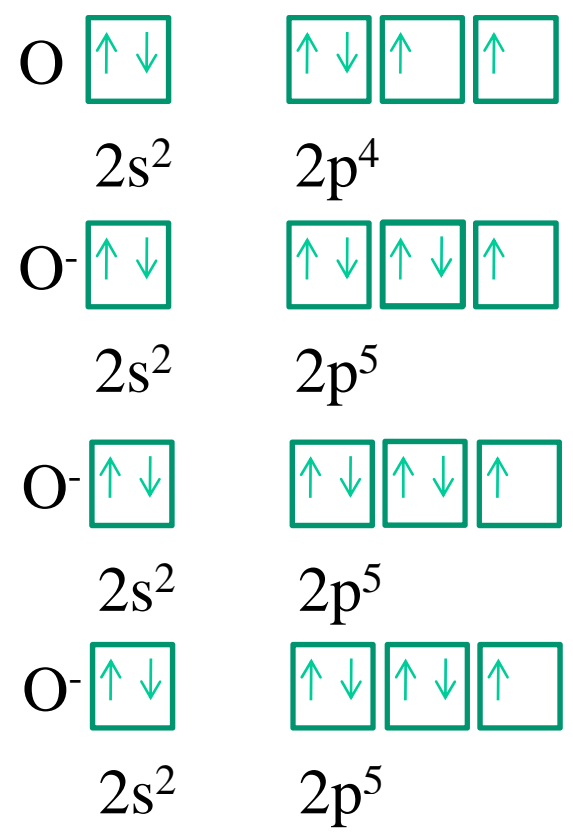
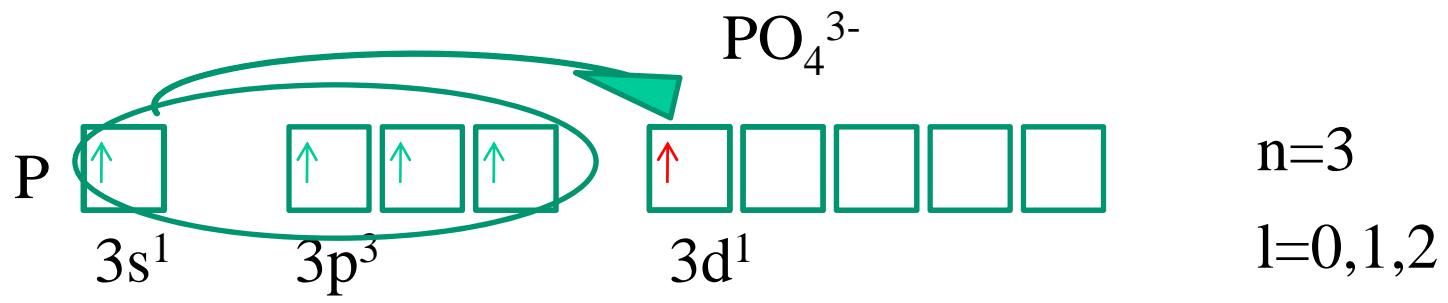

$y-c=4$   
 $c=0$   
 $y=4 \longrightarrow sp^3$   
 tetraedrica

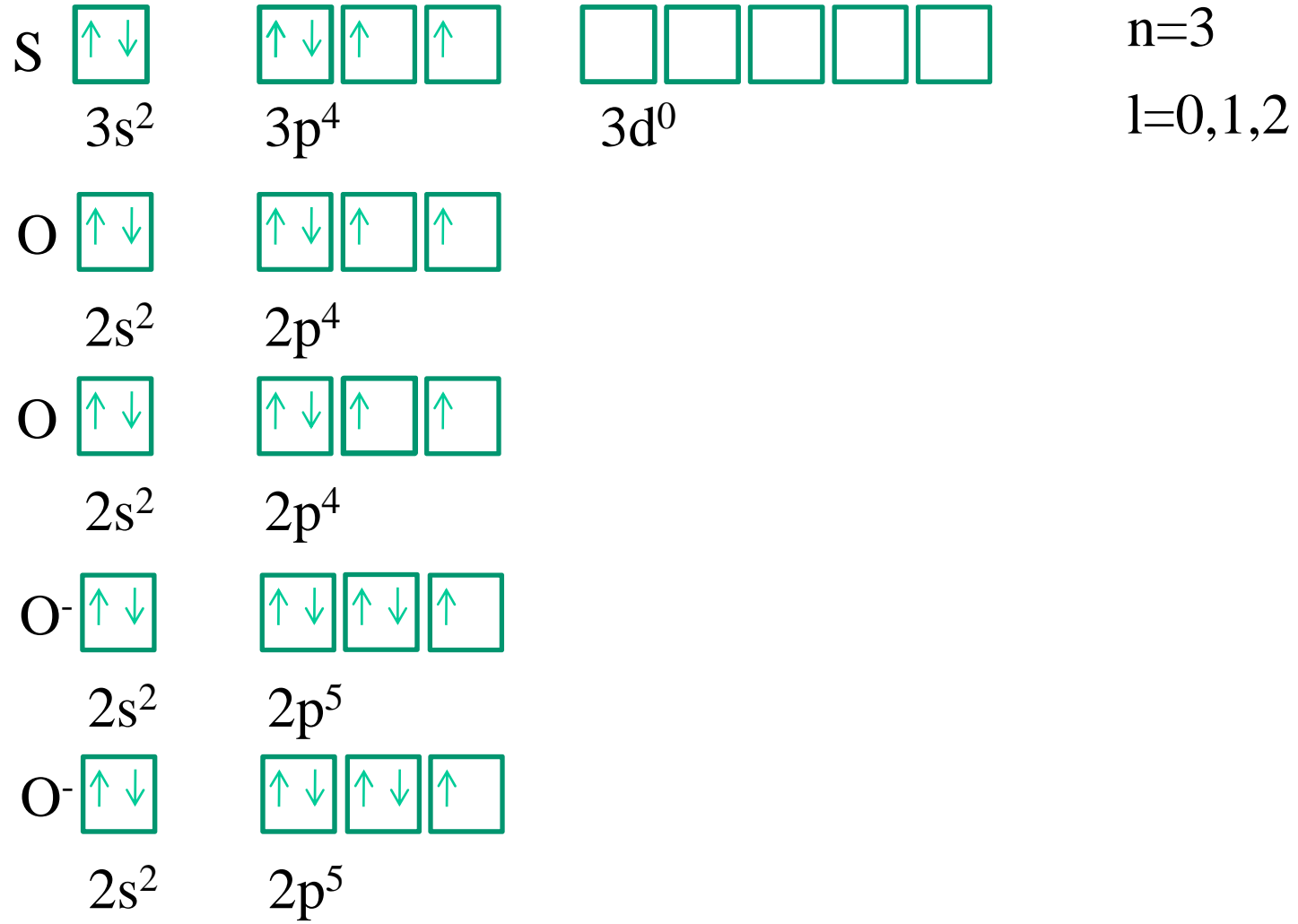



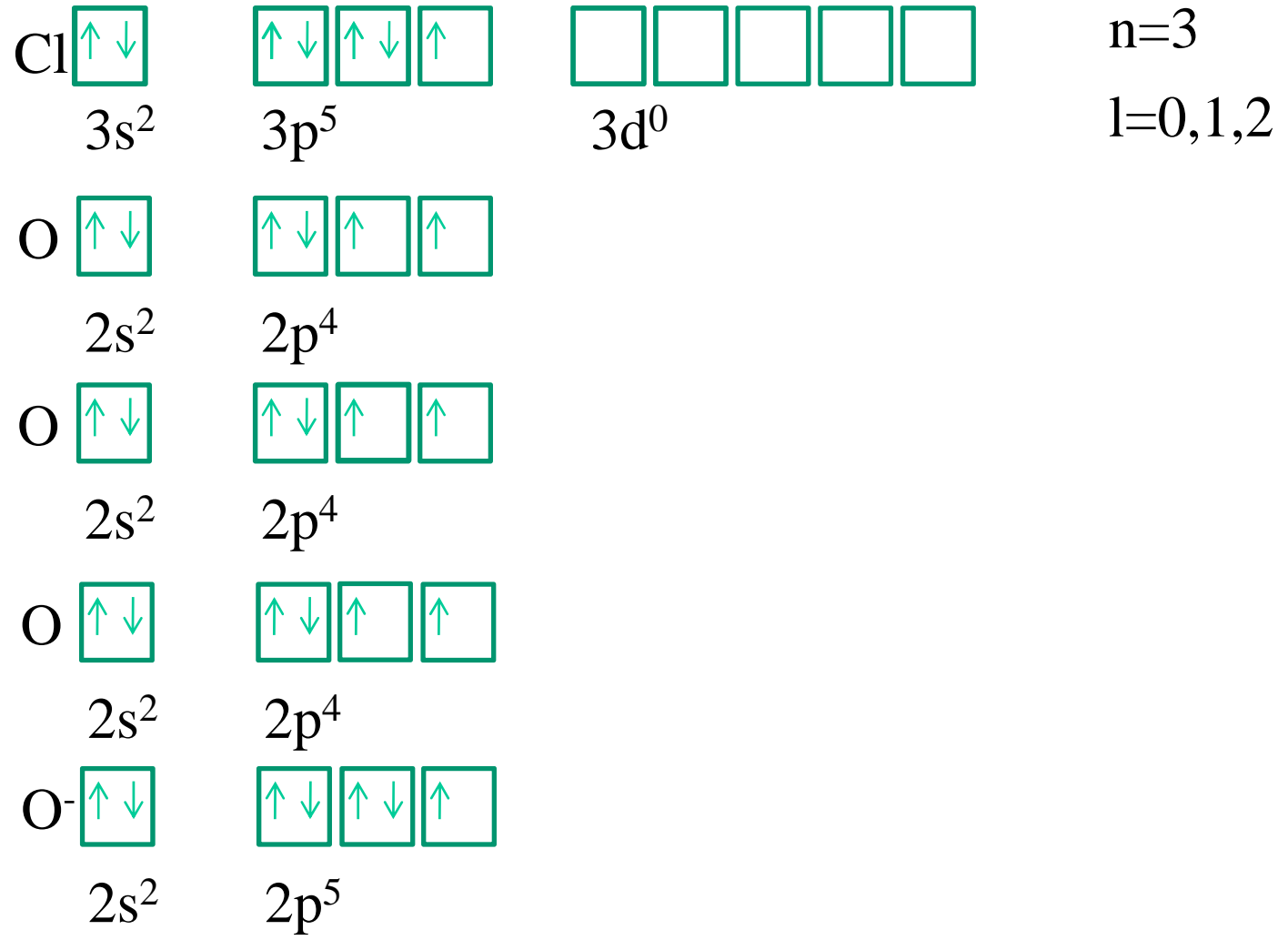



b) molecole con l'atomo centrale ibridizzato  $sp^3$ ,  
a geometria **piramidale trigonale**

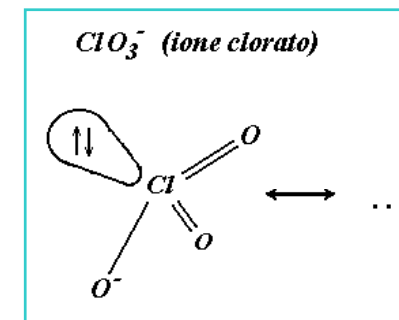
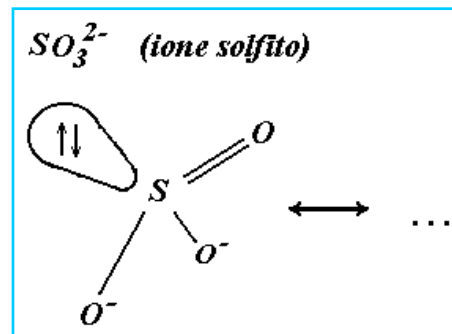
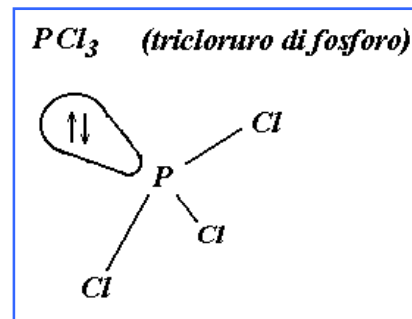
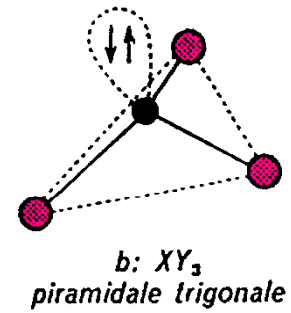
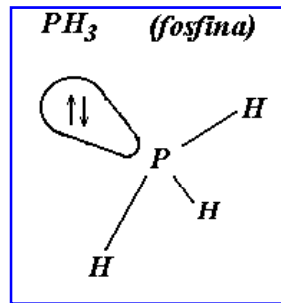
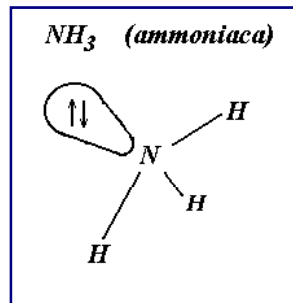



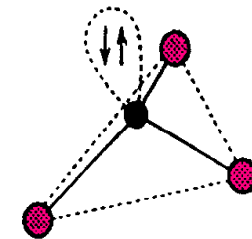
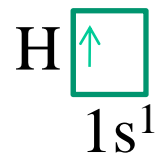
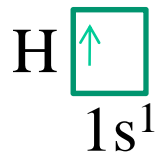
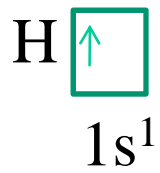
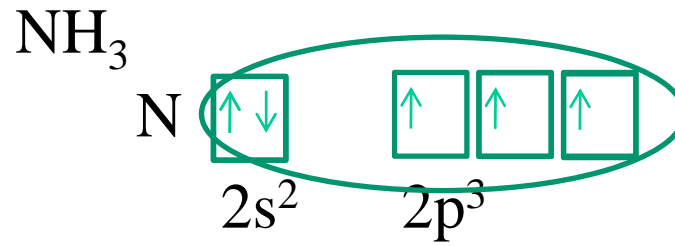
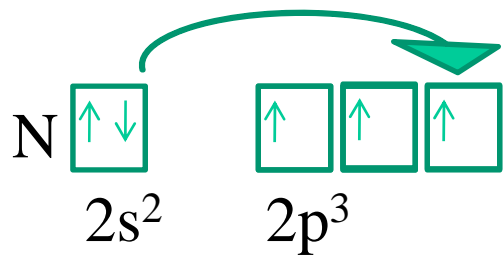

*b: XY<sub>3</sub>  
piramidale trigonale*

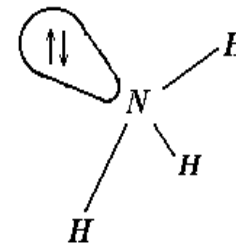

$$y - c = 3$$

$$c = 1$$

$$y = 4 \longrightarrow sp^3$$

Piramidale trigonale

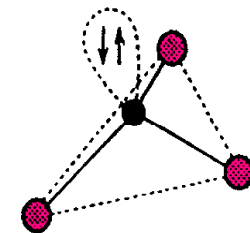
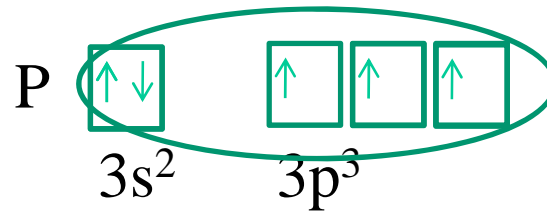
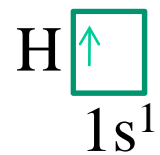
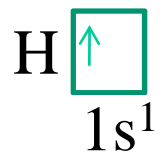
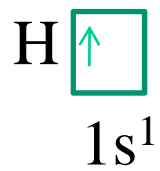
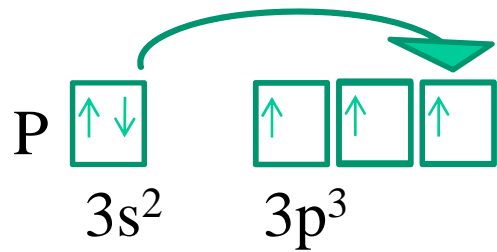

*b: XY<sub>3</sub>  
piramidale trigonale*

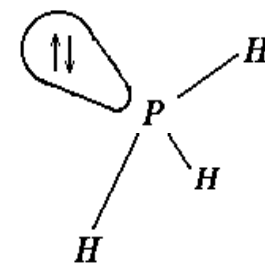

$$y - c = 3$$

$$c = 1$$

$$y = 4 \longrightarrow sp^3$$

Piramidale trigonale

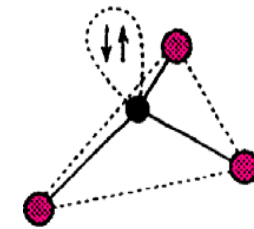
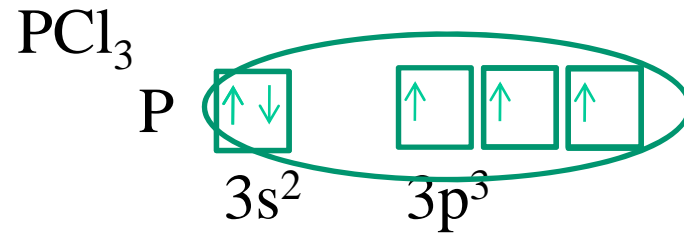
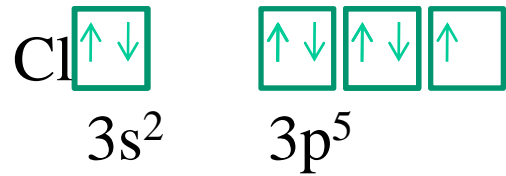
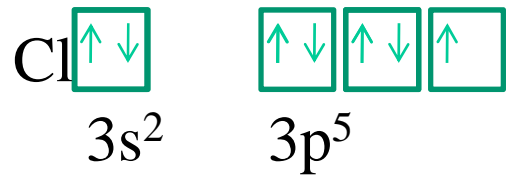
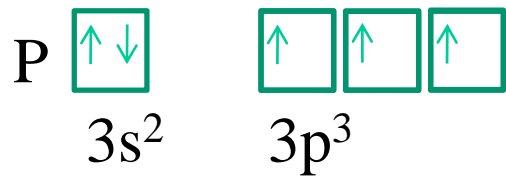

*b: XY<sub>3</sub>  
piramidale trigonale*

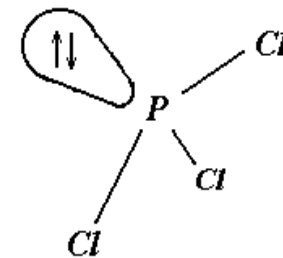

$y - c = 3$

$c = 1$

$y = 4 \longrightarrow sp^3$

Piramidale trigonale



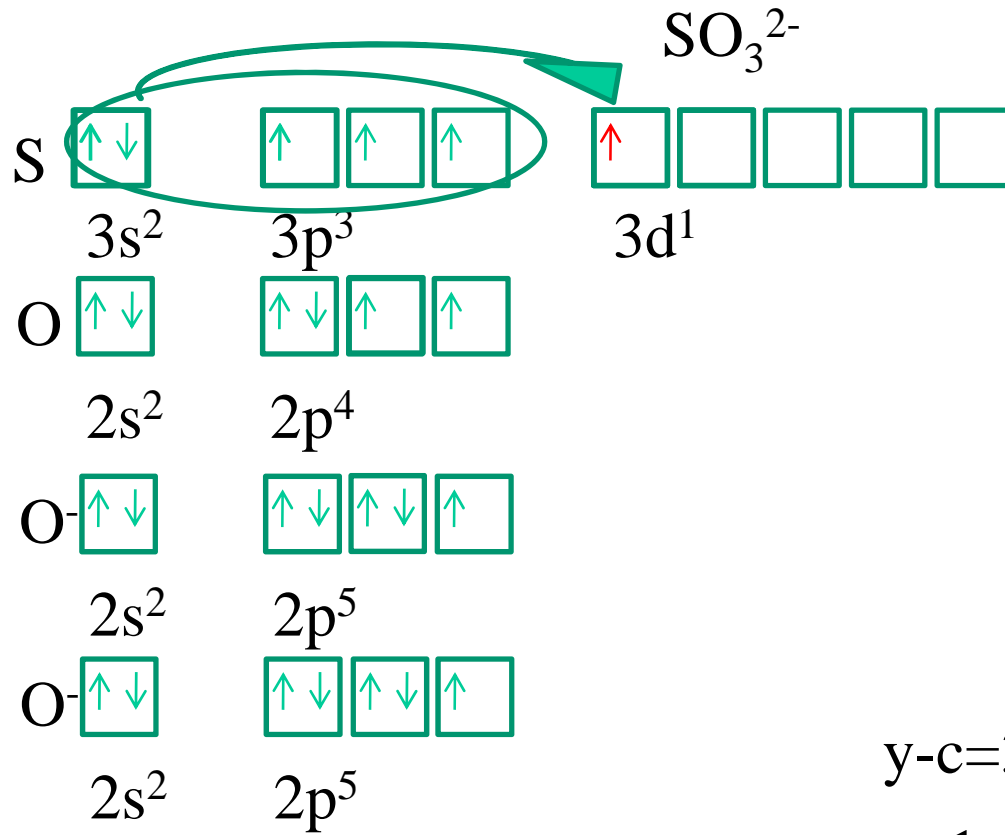

$n=3$   
 $l=0,1,2$

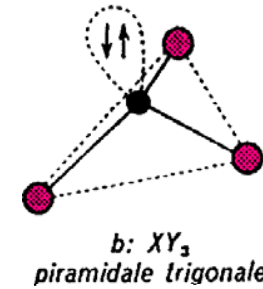

$y-c=3$   
 $c=1$

$y=4 \longrightarrow sp^3$

Piramidale trigonale

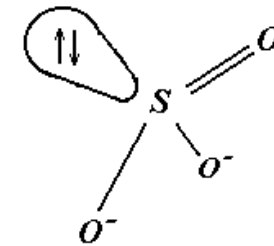

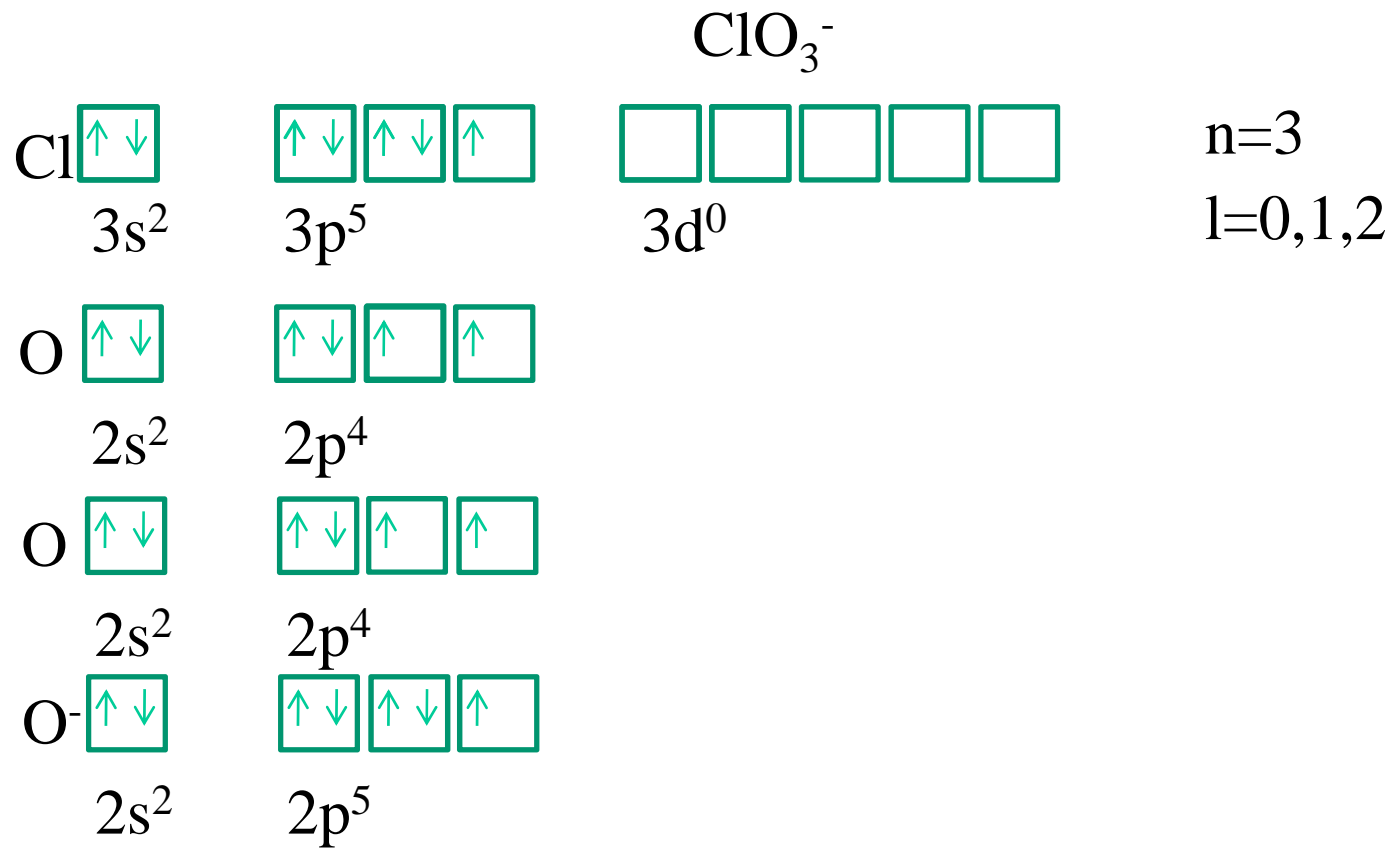

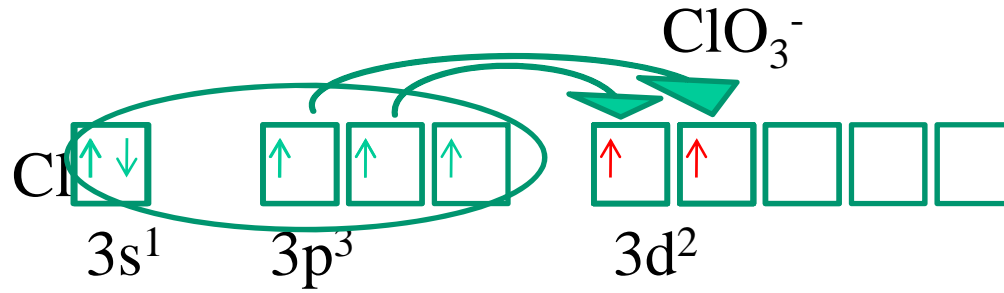

n=3

l=0,1,2

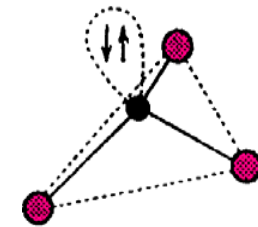
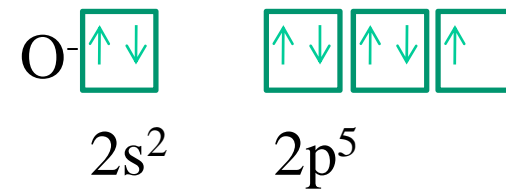
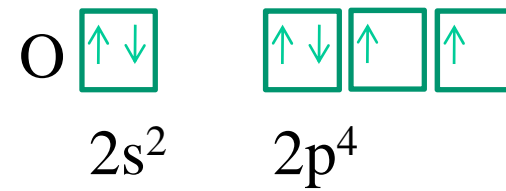

b: XY<sub>3</sub>  
piramidale trigonale

$$y - c = 3$$

$$c = 1$$

$$y = 4 \longrightarrow sp^3$$

Piramidale trigonale

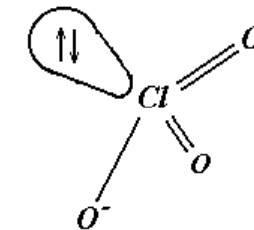

c) molecole con l'atomo centrale ibridizzato  $sp^3$ ,  
a geometria a  $\checkmark$

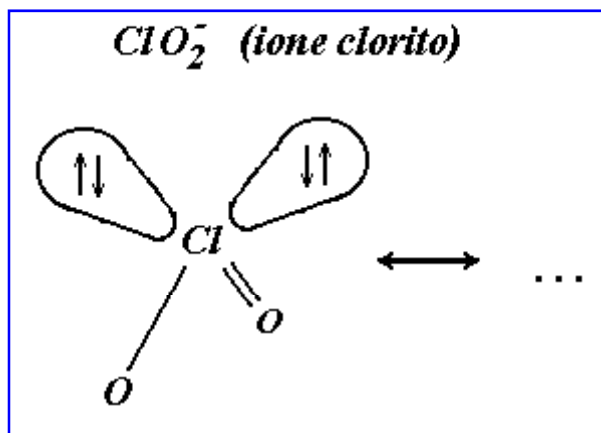
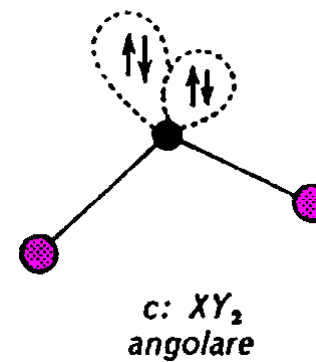
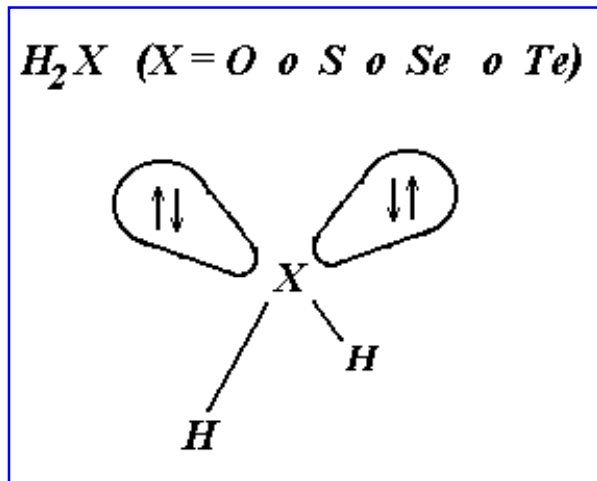



# H<sub>2</sub>O

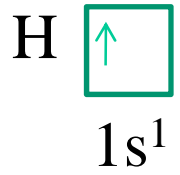
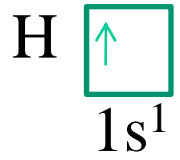
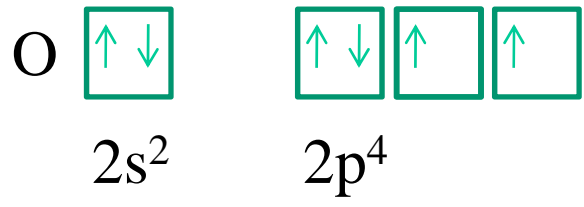

$y - c = 2$

$c = 2$

$y = 4 \longrightarrow sp^3$

angolare

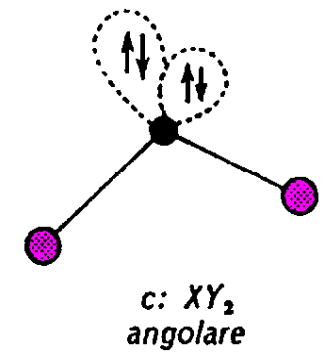

*H<sub>2</sub>X (X = O o S o Se o Te)*

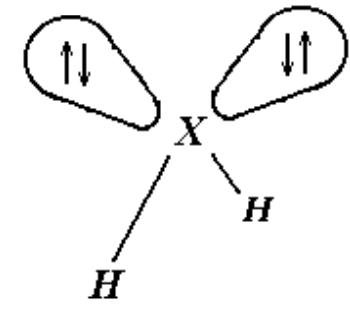

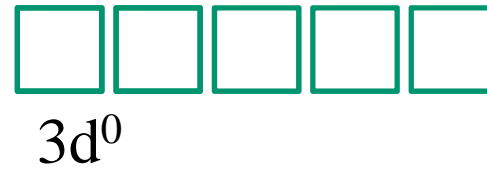
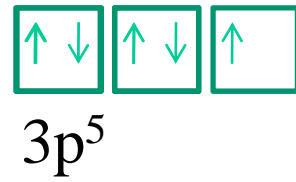
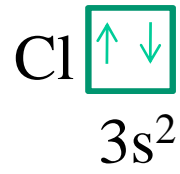

$n=3$   
 $l=0,1,2$

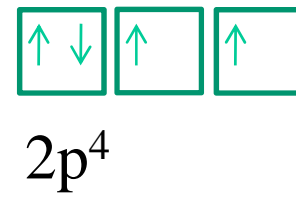
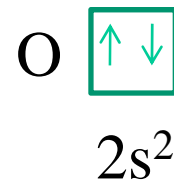
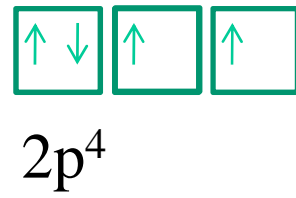
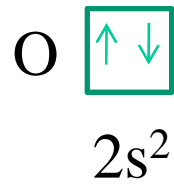

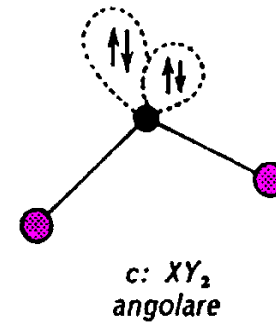
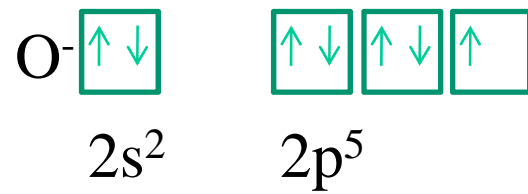
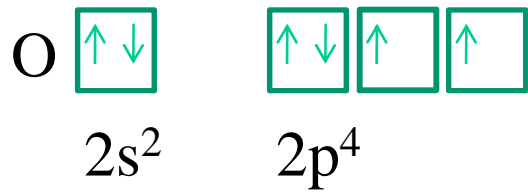
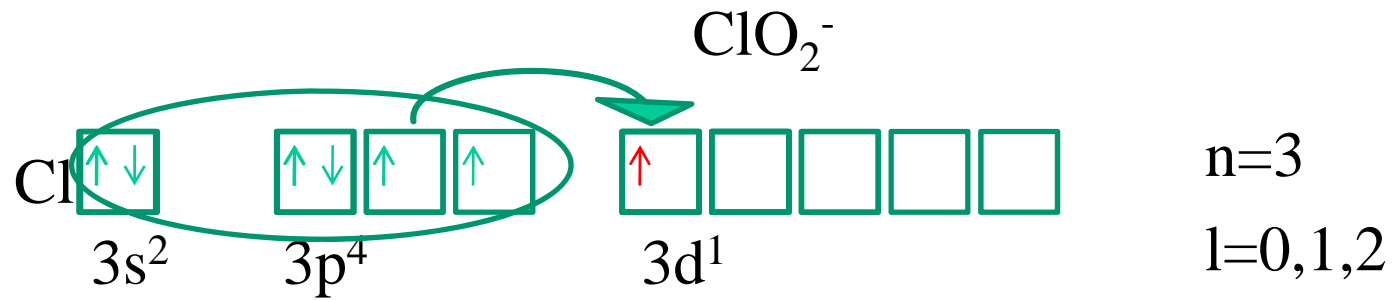

$y-c=2$

$c=2$

$y=4 \longrightarrow sp^3$

angolare

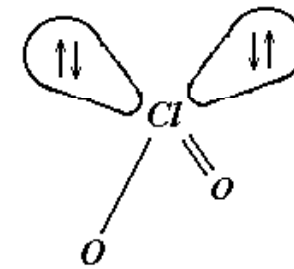

IV a) molecole con l'atomo centrale ibridizzato  $sp^3d$ ,  
a geometria a ***bipiramidale trigonale***

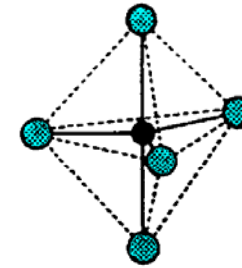

a:  $XY_5$   
*bipiramidale trigonale*

***$PCl_5$  (pentacloruro di fosforo)***

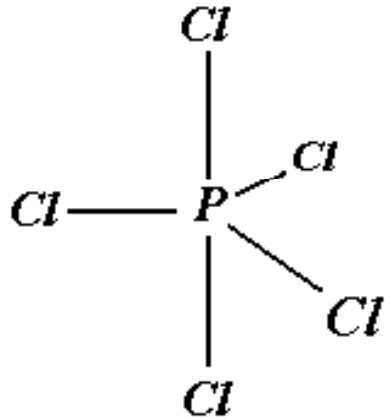

***$AsF_5$  (pentafluoruro di arsenico)***

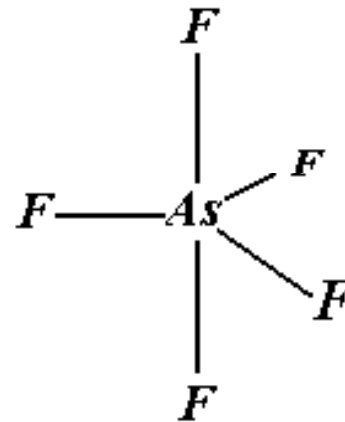

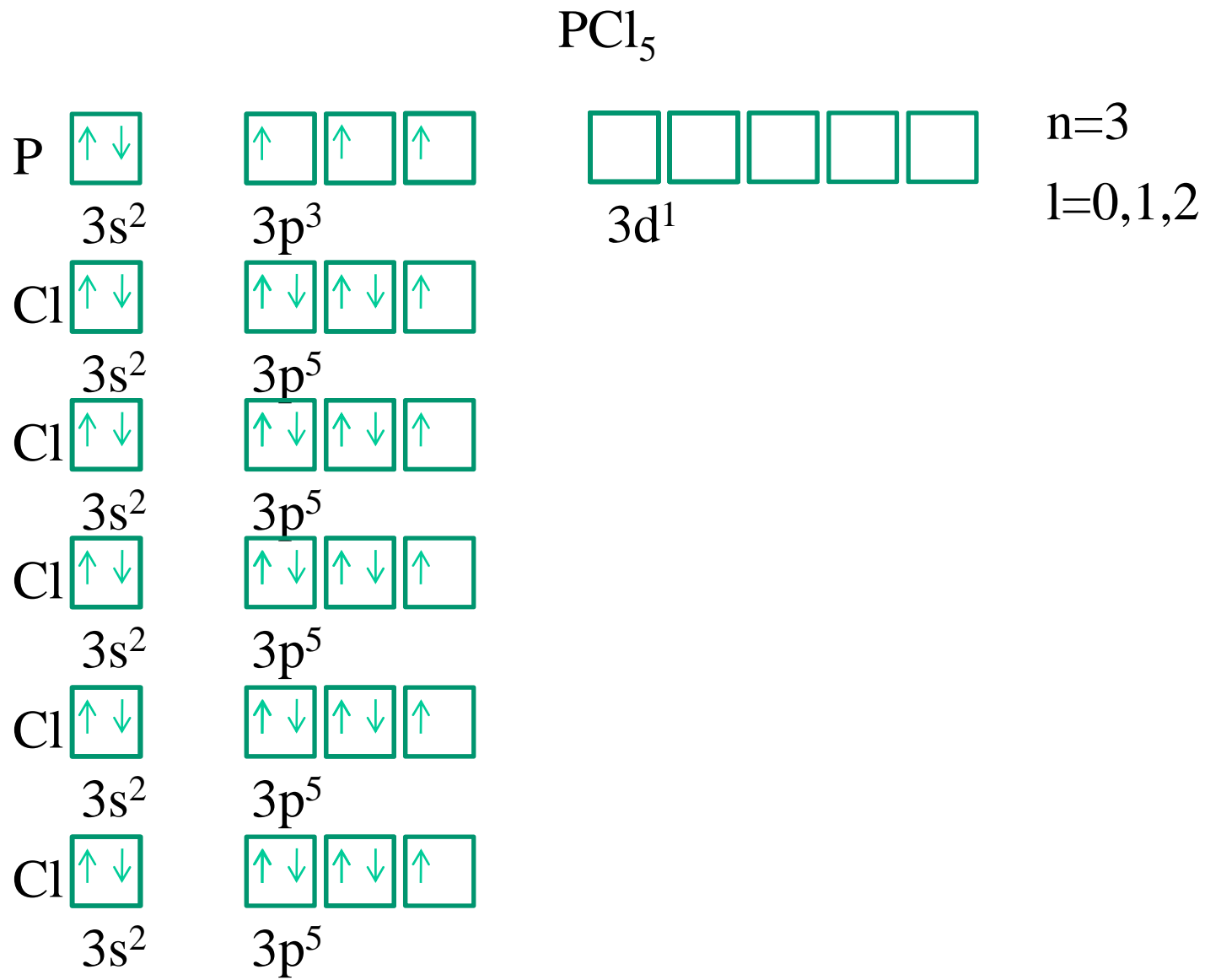

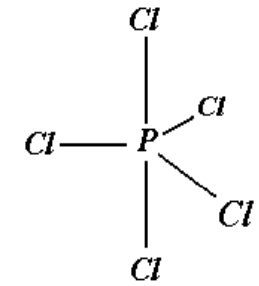
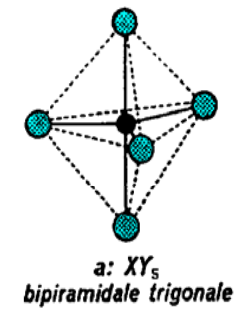
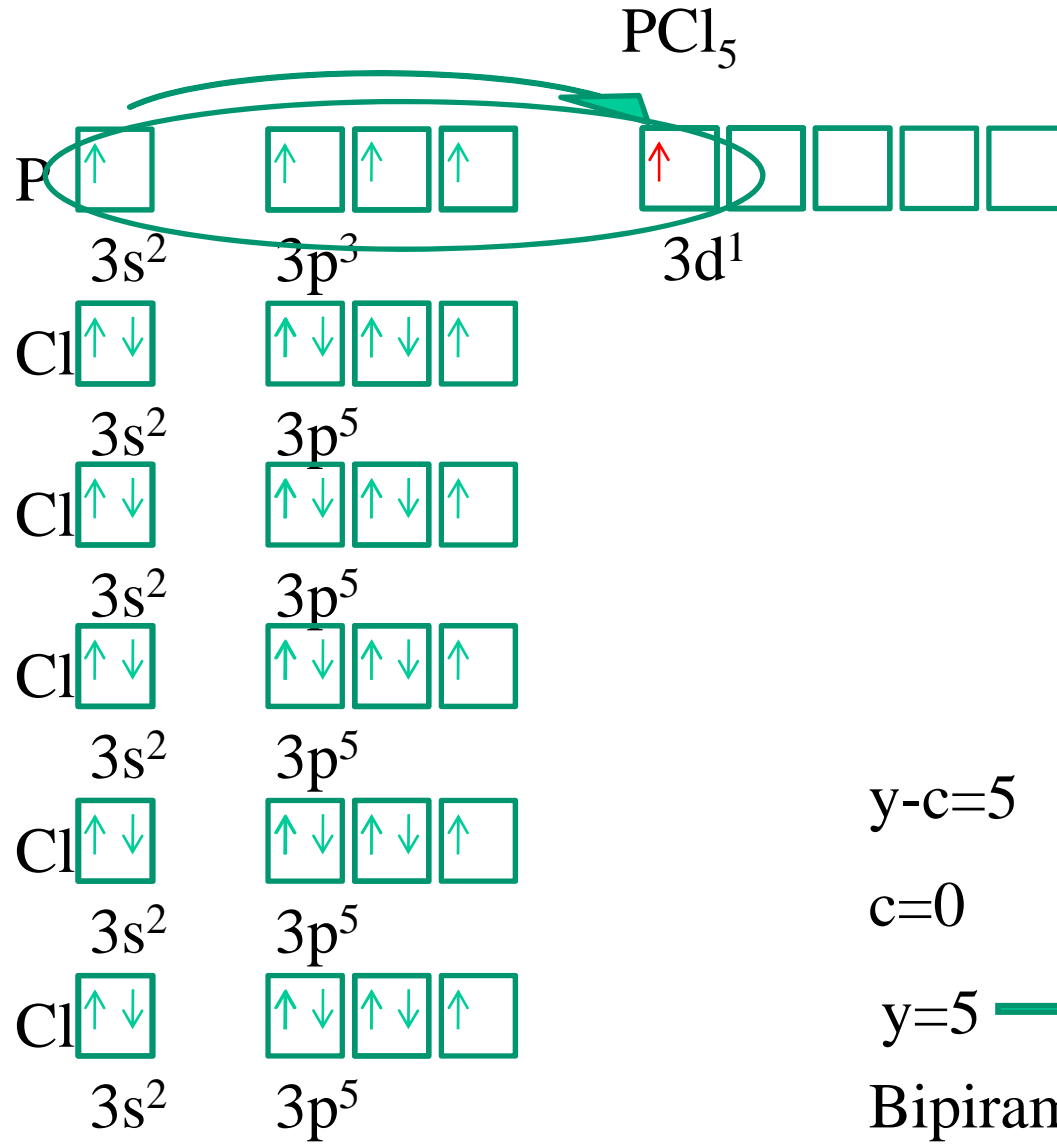

$y - c = 5$

$c = 0$

$y = 5 \longrightarrow sp^3d$

Bipiramidale trigonale

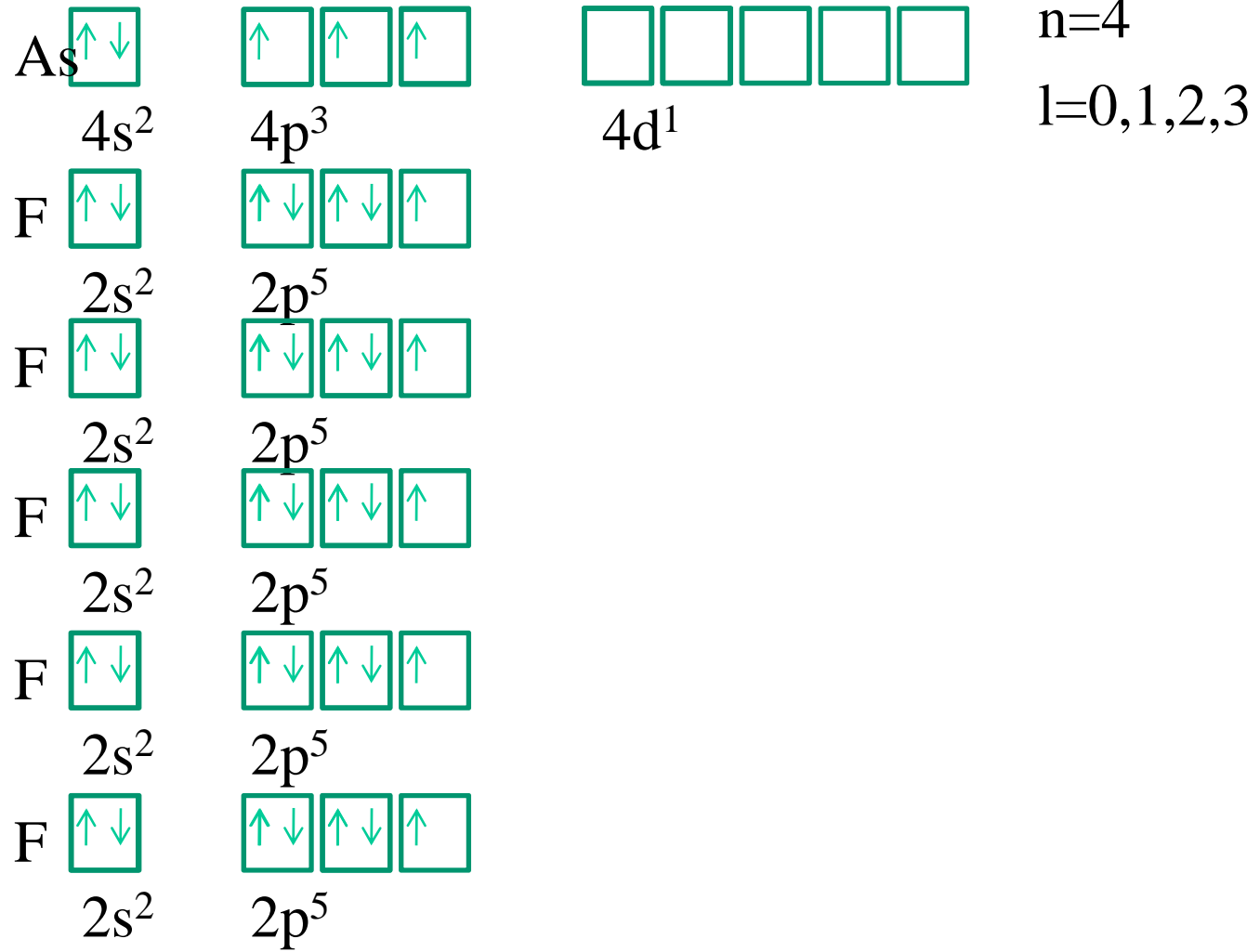

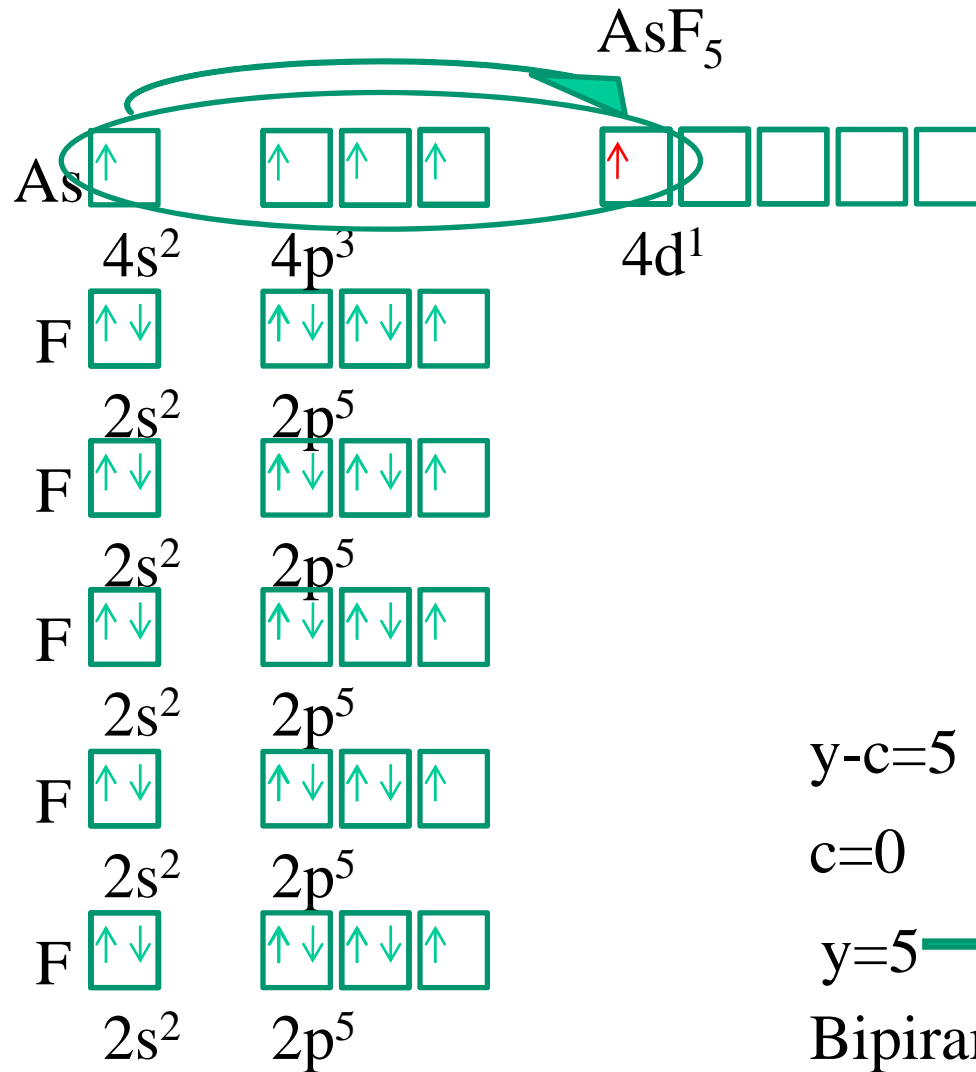

$n=4$   
 $l=0,1,2,3$

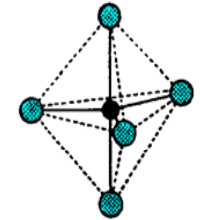

a:  $\text{XY}_5$   
bipiramidale trigonale

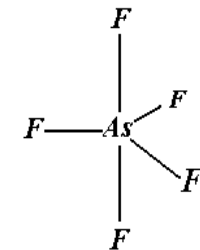

$y-c=5$

$c=0$

$y=5 \longrightarrow sp^3d$

Bipiramidale trigonale



b) molecole con l'atomo centrale ibridizzato  $sp^3d$ ,  
a geometria ***tetraedrica irregolare***

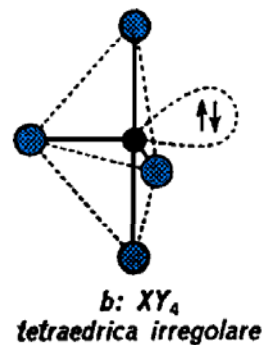
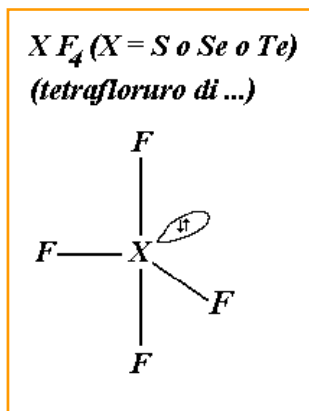

c) molecole con l'atomo centrale ibridizzato  $sp^3d$ ,  
con geometria a ***T***

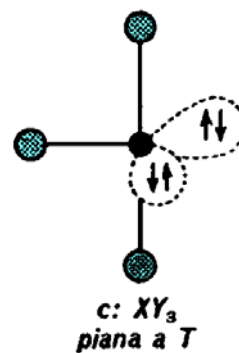
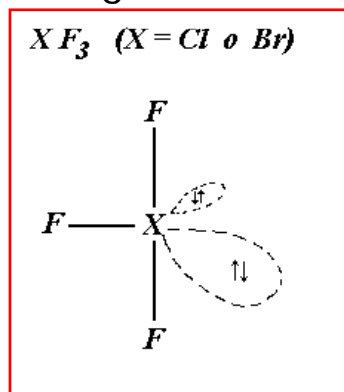

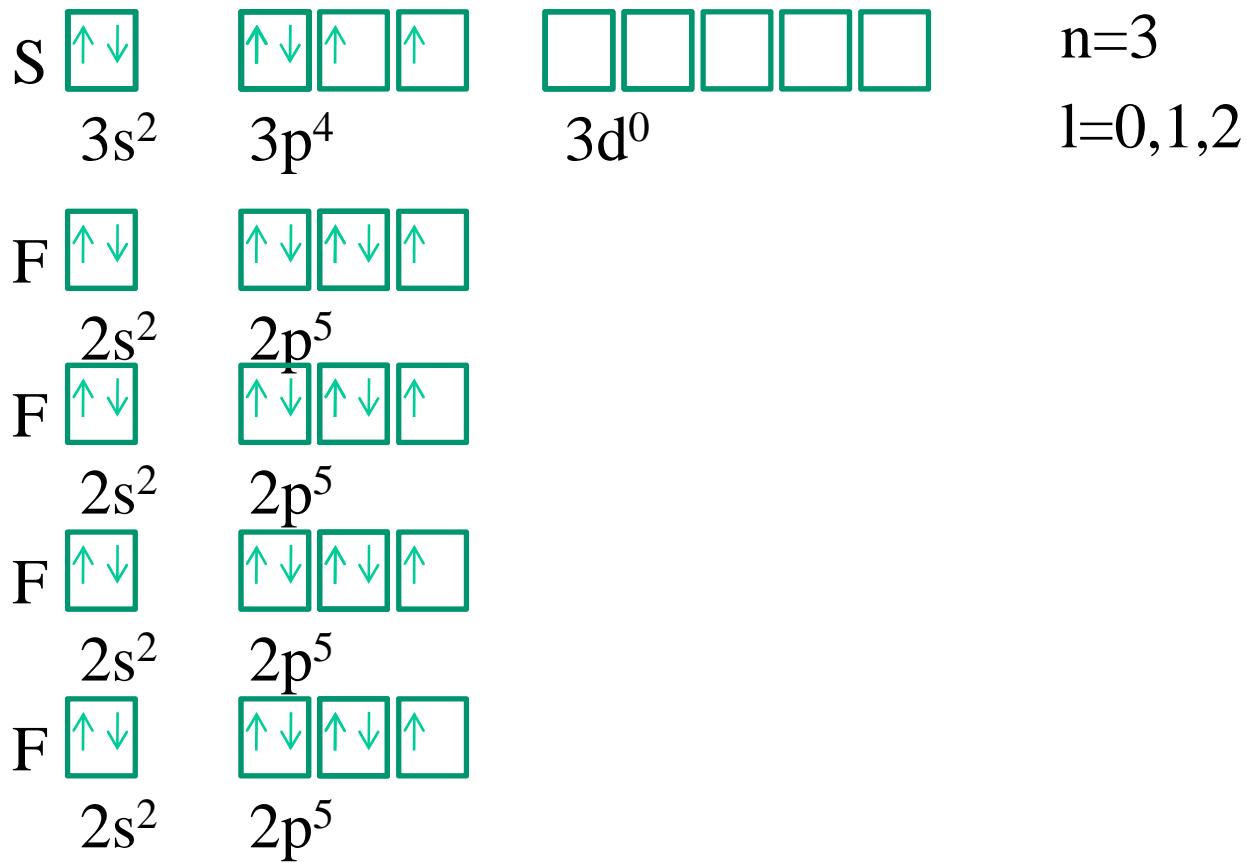

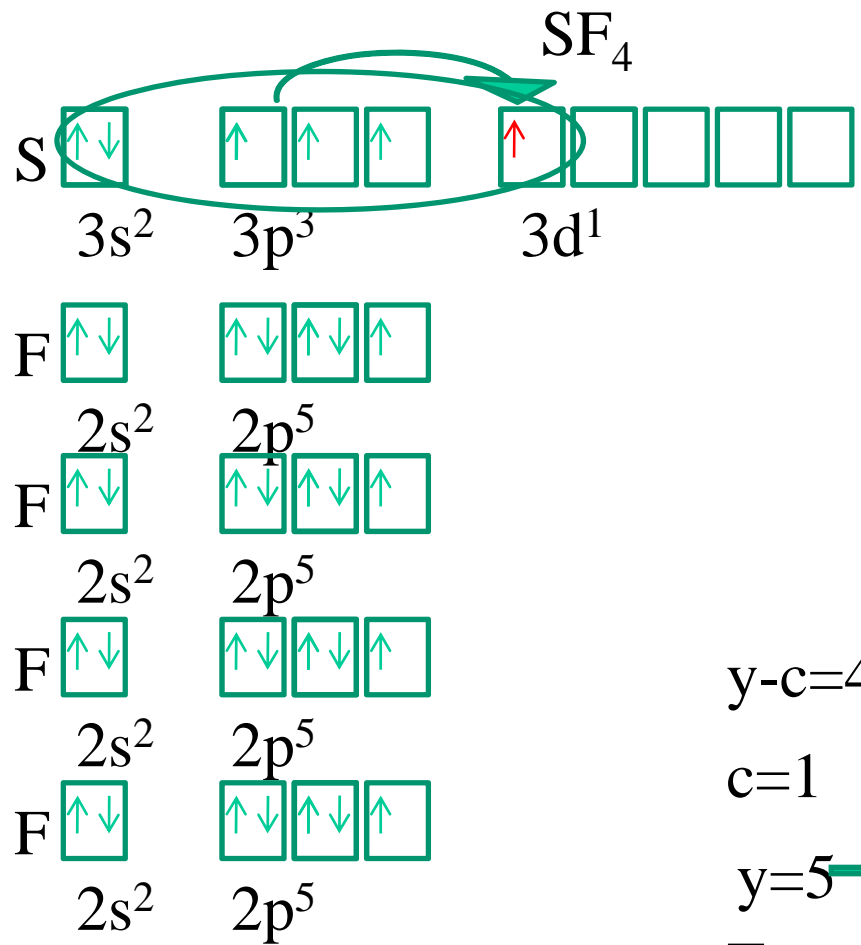

$n=3$   
 $l=0,1,2$

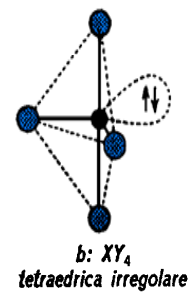
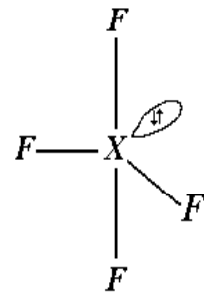

$y-c=4$

$c=1$

$y=5 \longrightarrow sp^3d$

Tetraedrica irregolare

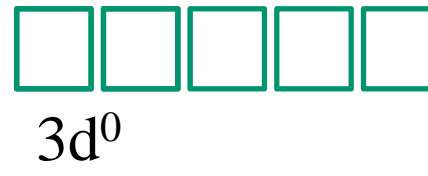
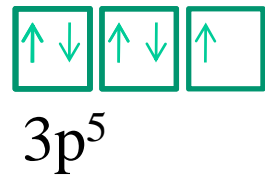

$n=3$

$l=0,1,2$

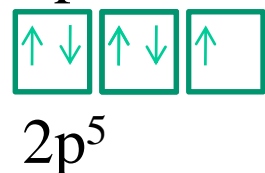
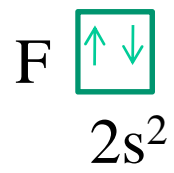
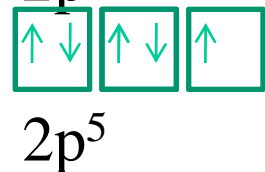
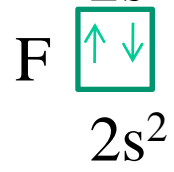
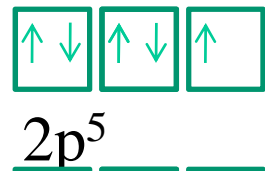
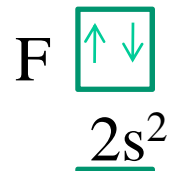

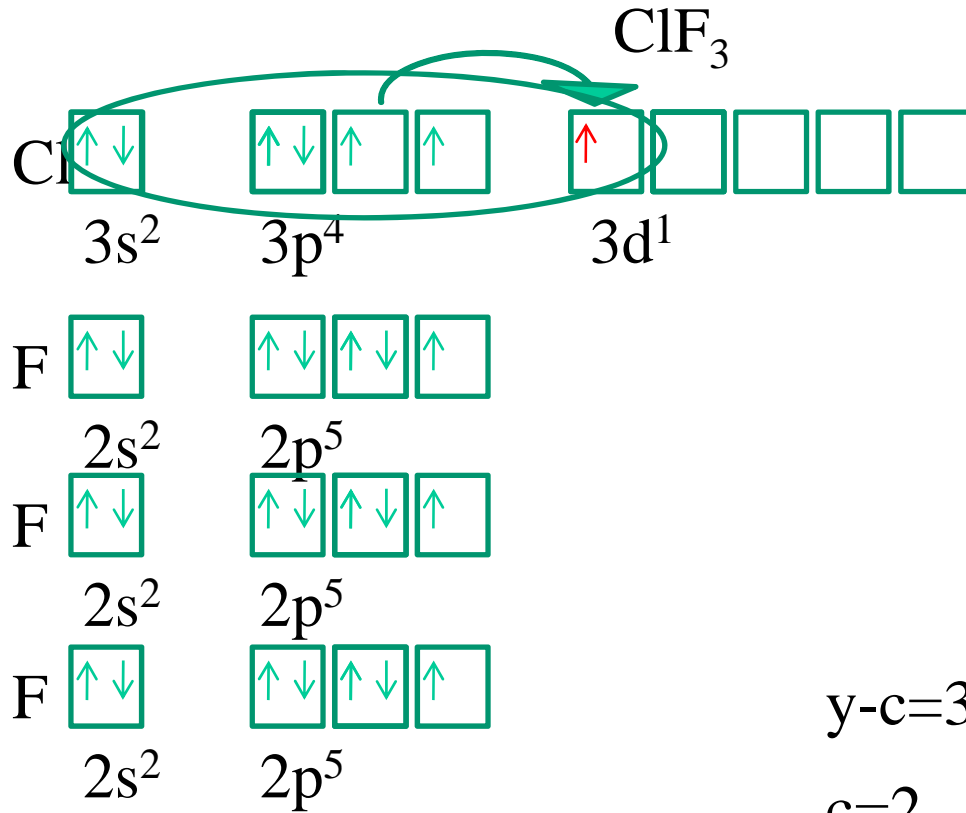

$n=3$   
 $l=0,1,2$

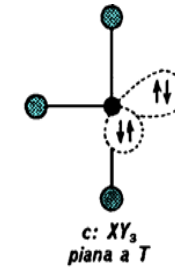

$y-c=3$

$c=2$



Piana a T

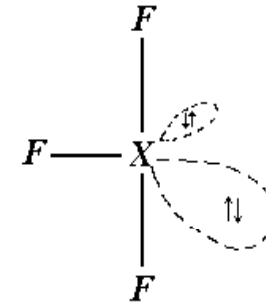

d) molecole con l'atomo centrale ibridizzato  $sp^3d$ ,  
con geometria a *lineare*

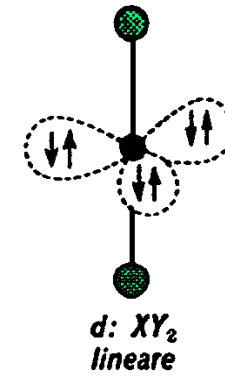
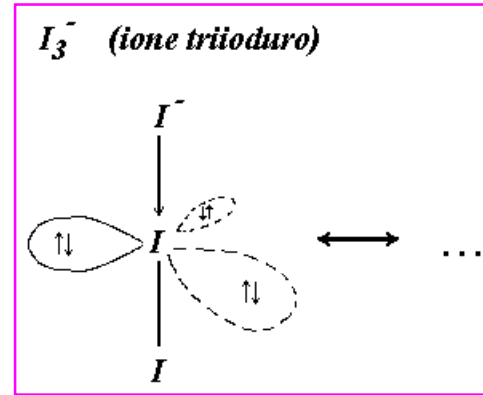
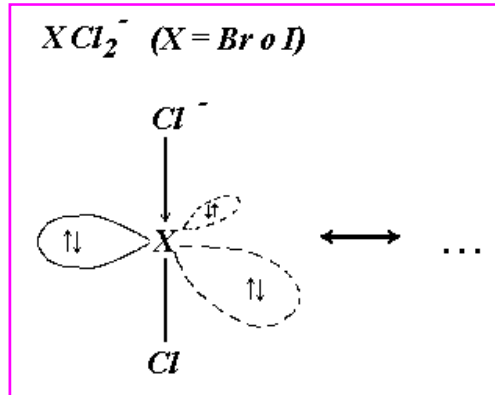

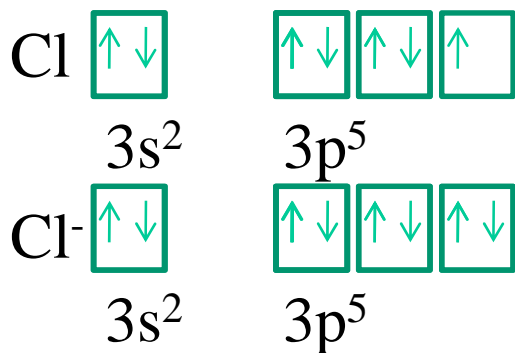
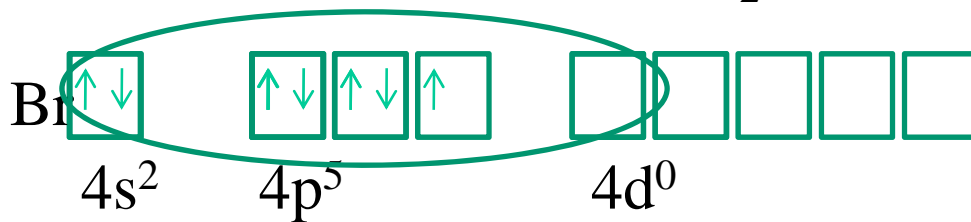

Lineare

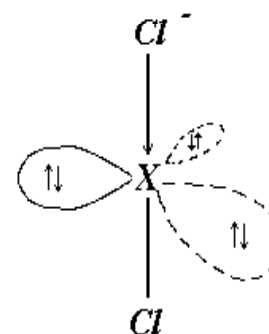
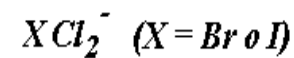
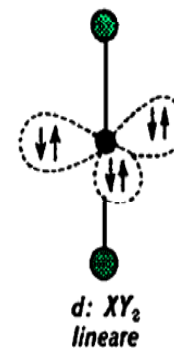

$y - c = 2$

$c = 3$

$y = 5 \longrightarrow sp^3d$

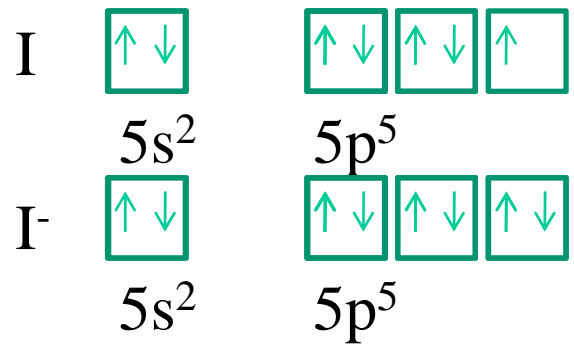
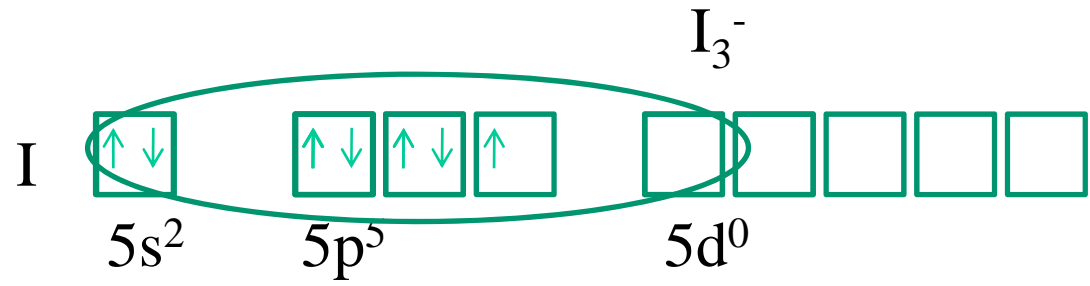

Lineare

$$y - c = 2$$

$$c = 3$$

$$y = 5 \longrightarrow sp^3d$$

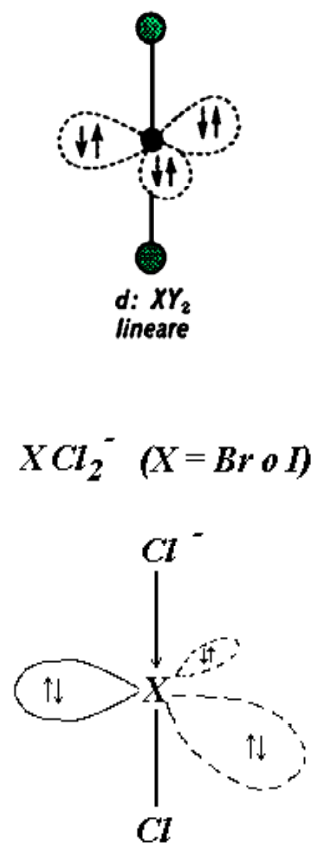



V a) molecole con l'atomo centrale ibridizzato  $sp^3d^2$ ,  
a geometria a **ottaedrica**

$SiF_6^{2-}$  (ione esafluoro silicato)

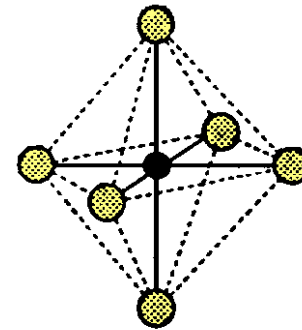
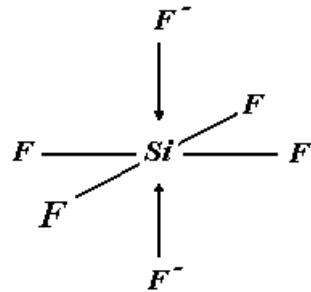

a:  $XY_6$   
ottaedrica

$PF_6^-$  (ione esafluorofosfato)

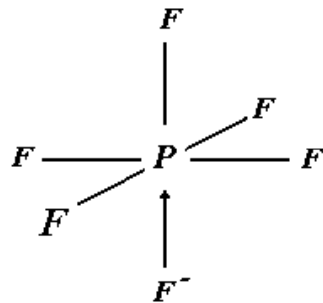

$XF_6$  ( $X = S$  o  $Se$ ) (esafluoruro di ...)

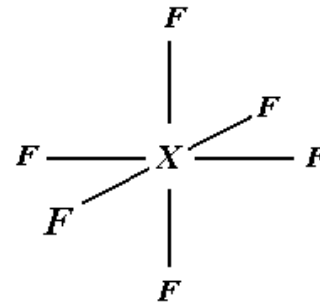

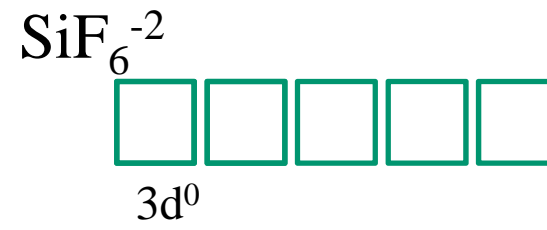
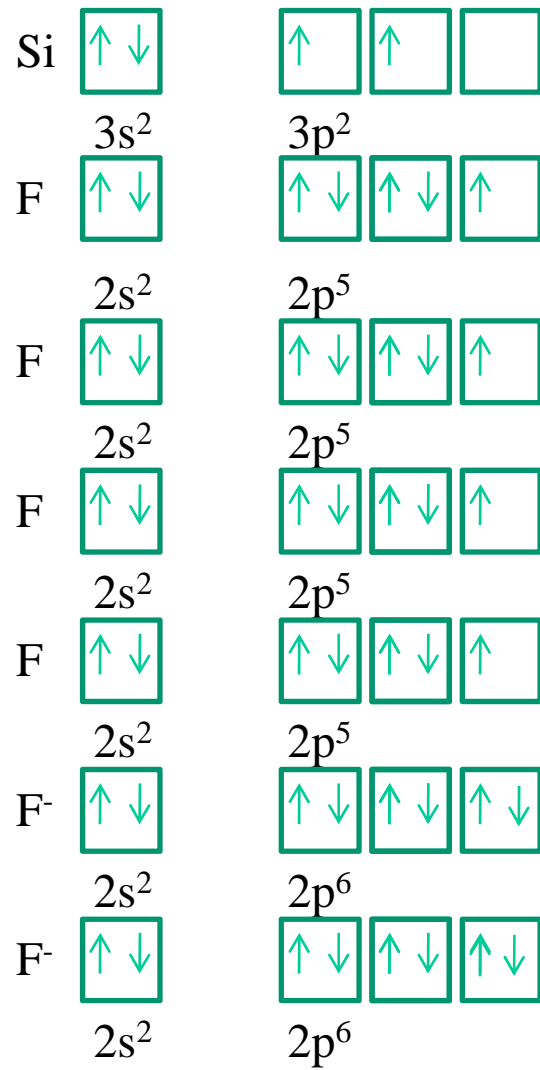

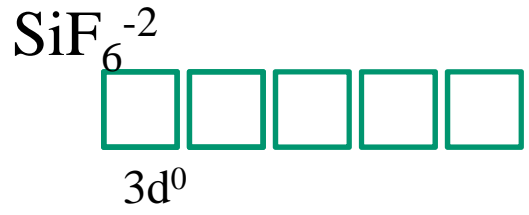
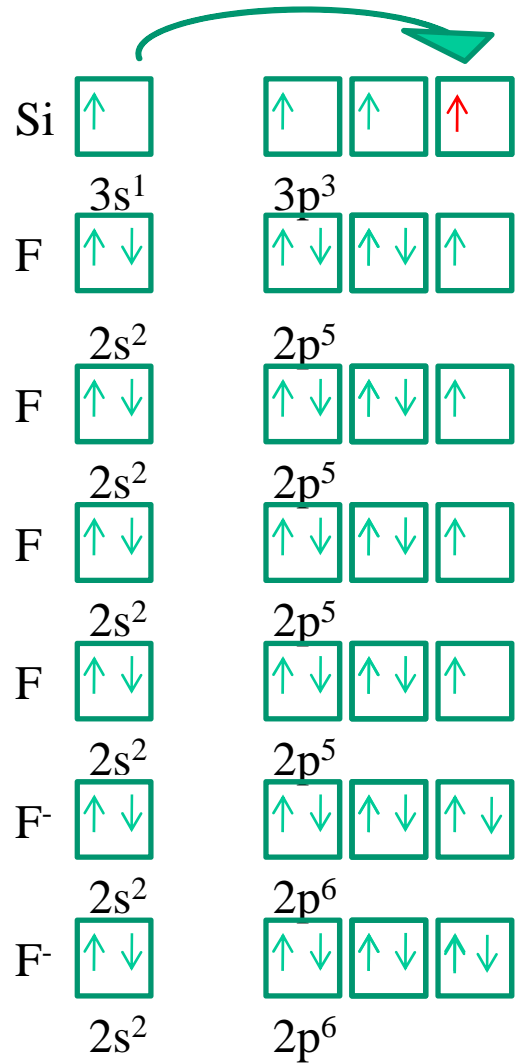

$y-c=6$

$c=0$

$y=6 \longrightarrow sp^3d^2$

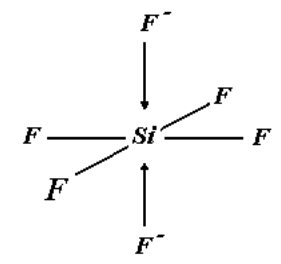
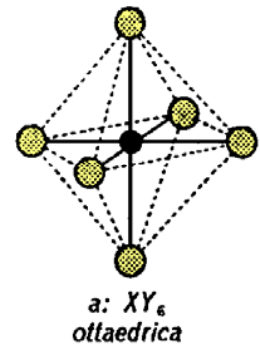

Ottaedrica

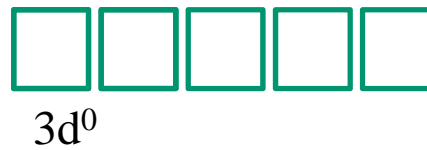
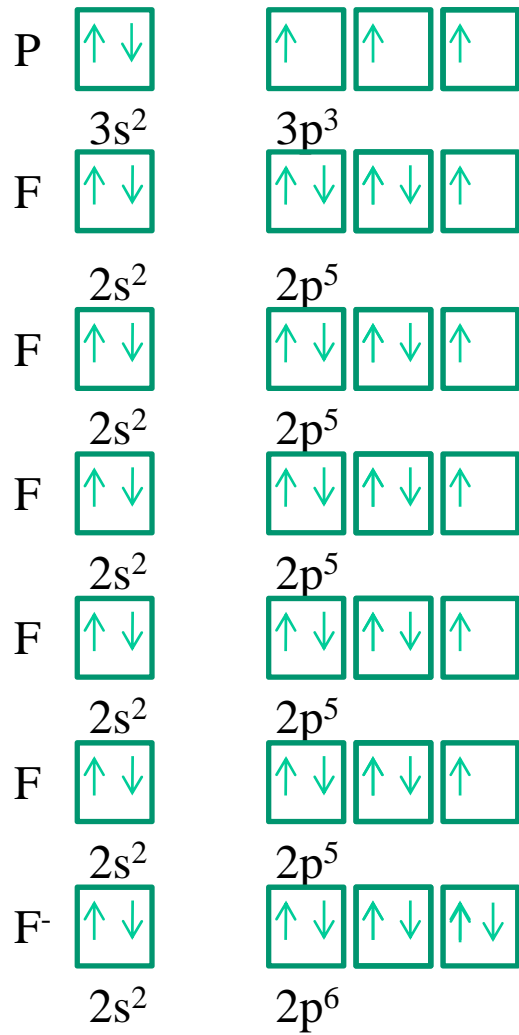

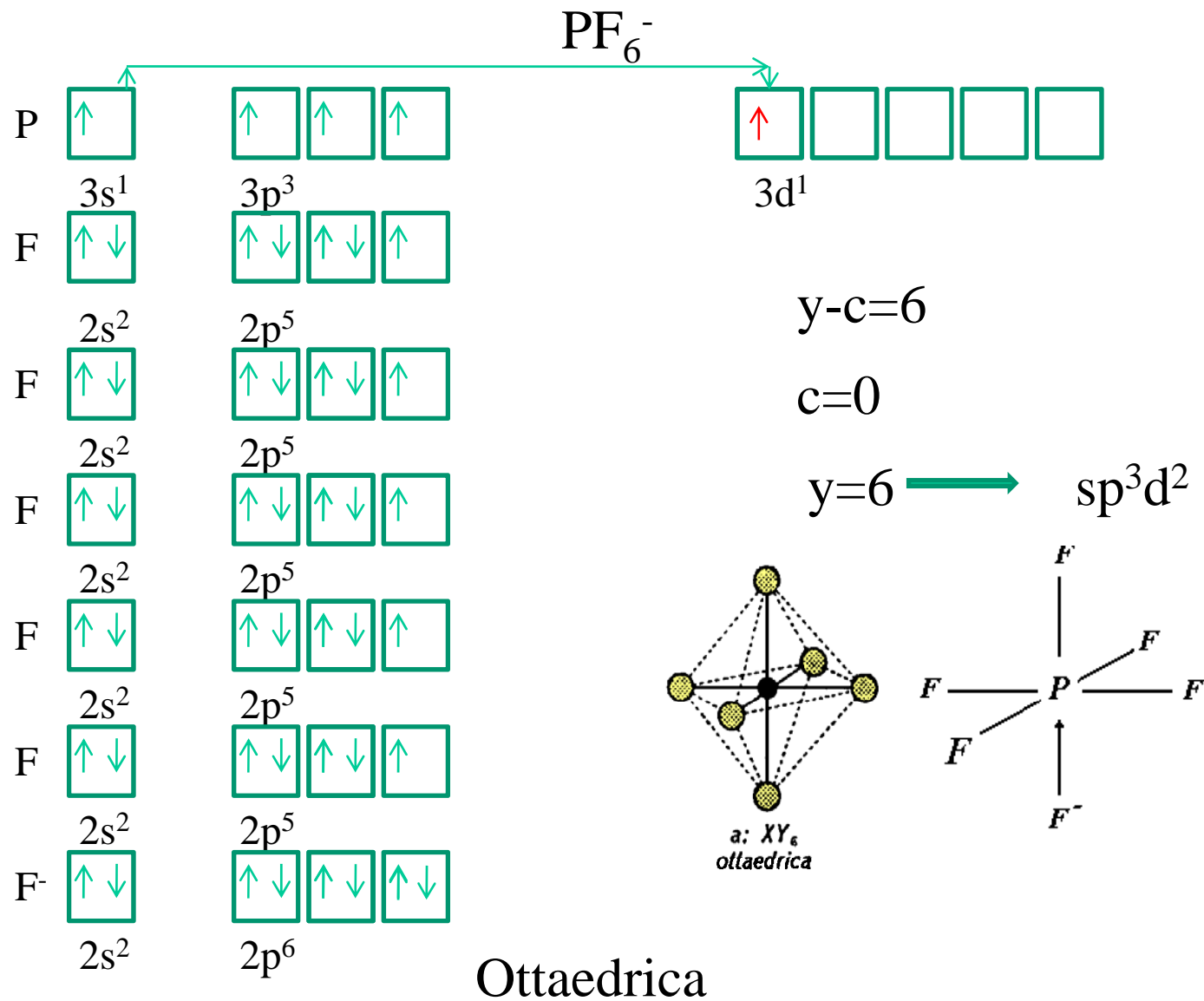

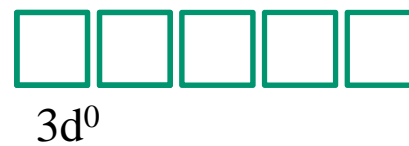
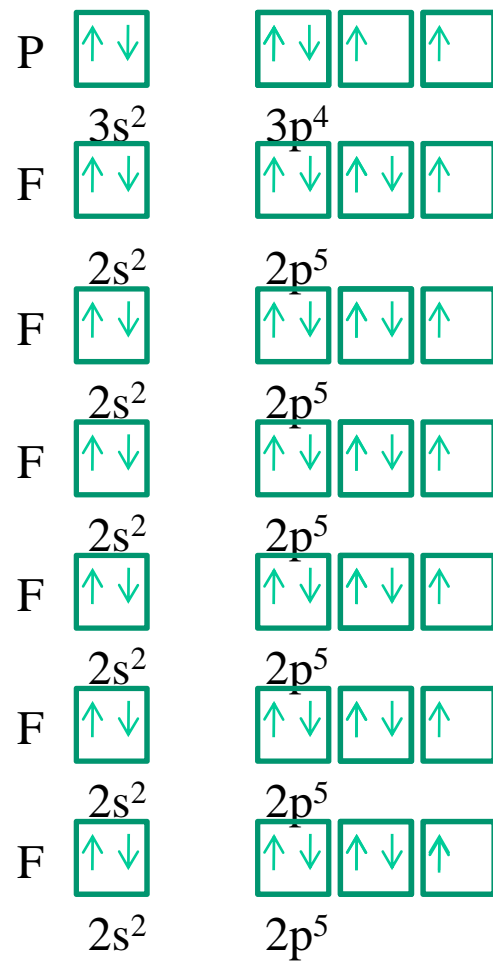

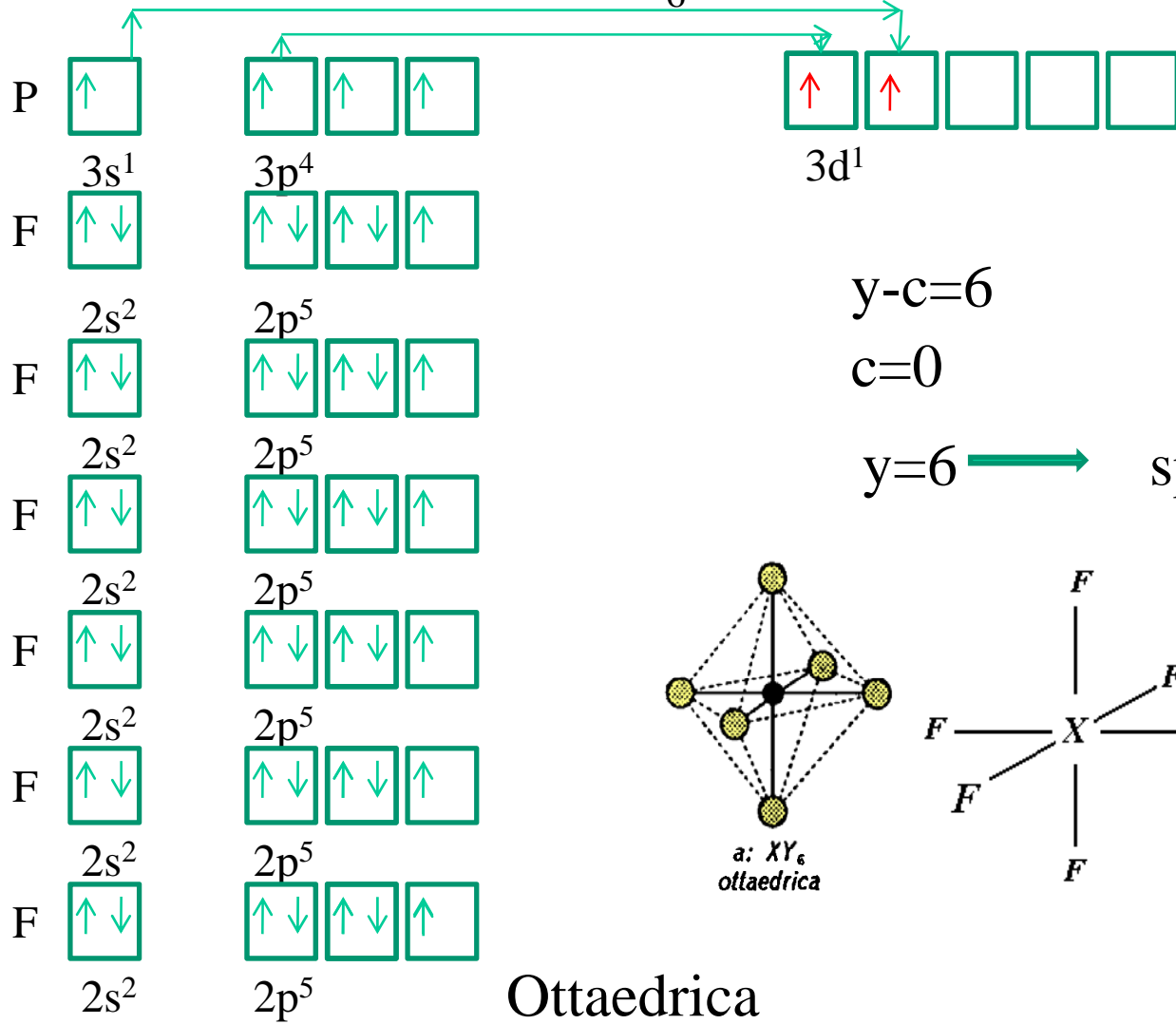

$$y - c = 6$$

$$c = 0$$

$$y = 6 \longrightarrow sp^3d^2$$

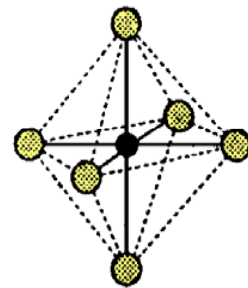

a:  $XY_6$   
octaedrica

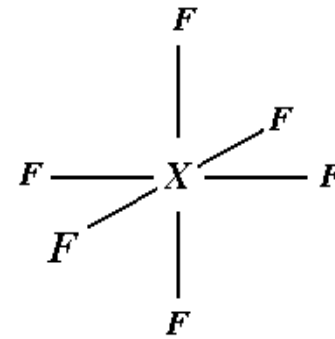

Octaedrica

b) molecole con l'atomo centrale ibridizzato  $sp^3d^2$ ,  
a geometria a **piramidale tetragonale**

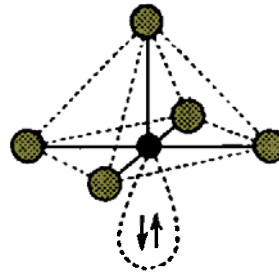

b:  $XY_5$   
piramidale tetragonale

$SbF_5^{2-}$  (ione pentafluoroantimoniato)

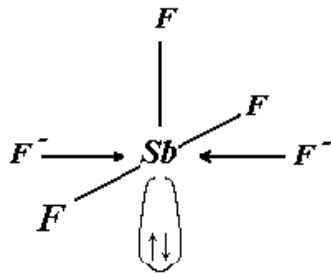

$XF_5$  ( $X = Br$  o  $I$ ) (pentafluoruro di ...)

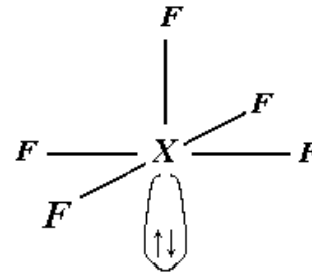



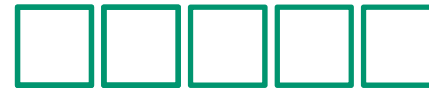
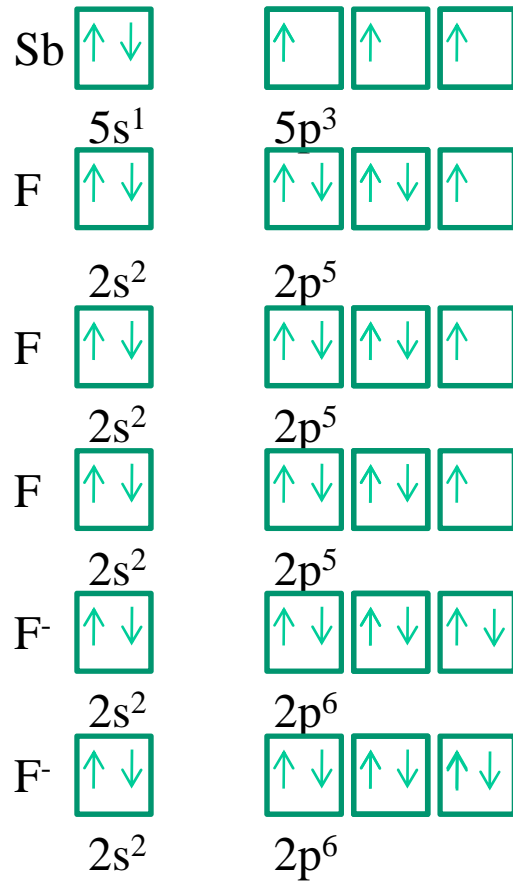
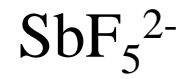

$5d^0$

$y - c = 5$

$c = 1$

$y = 6 \longrightarrow sp^3d^2$

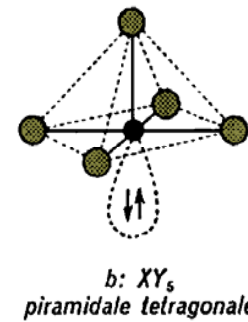
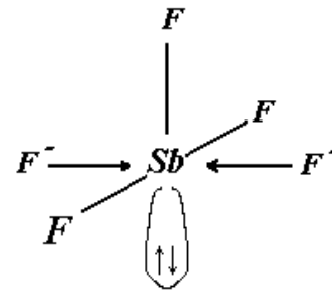

Piramidale tetragonale

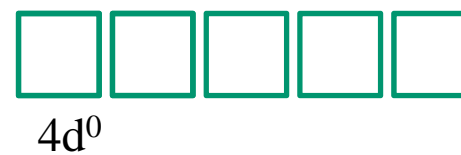
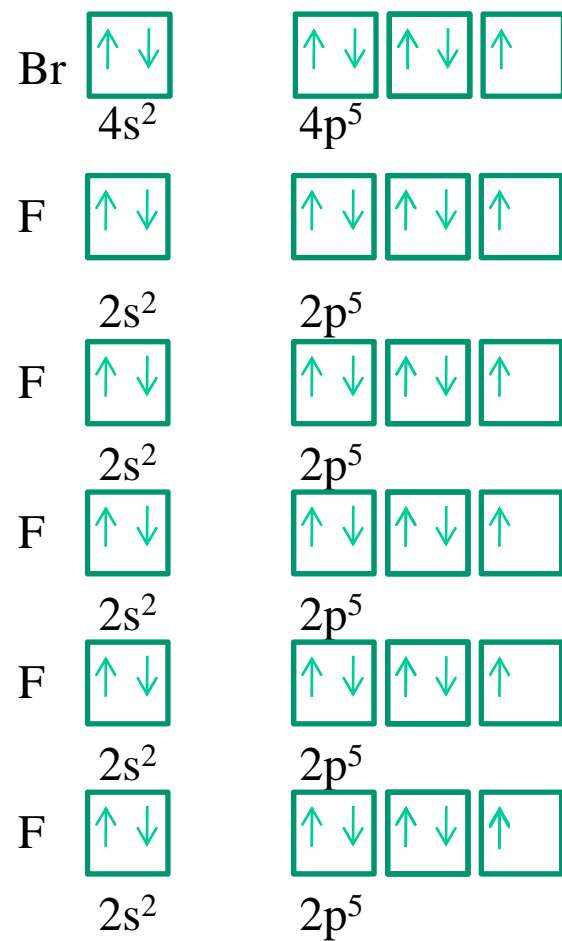

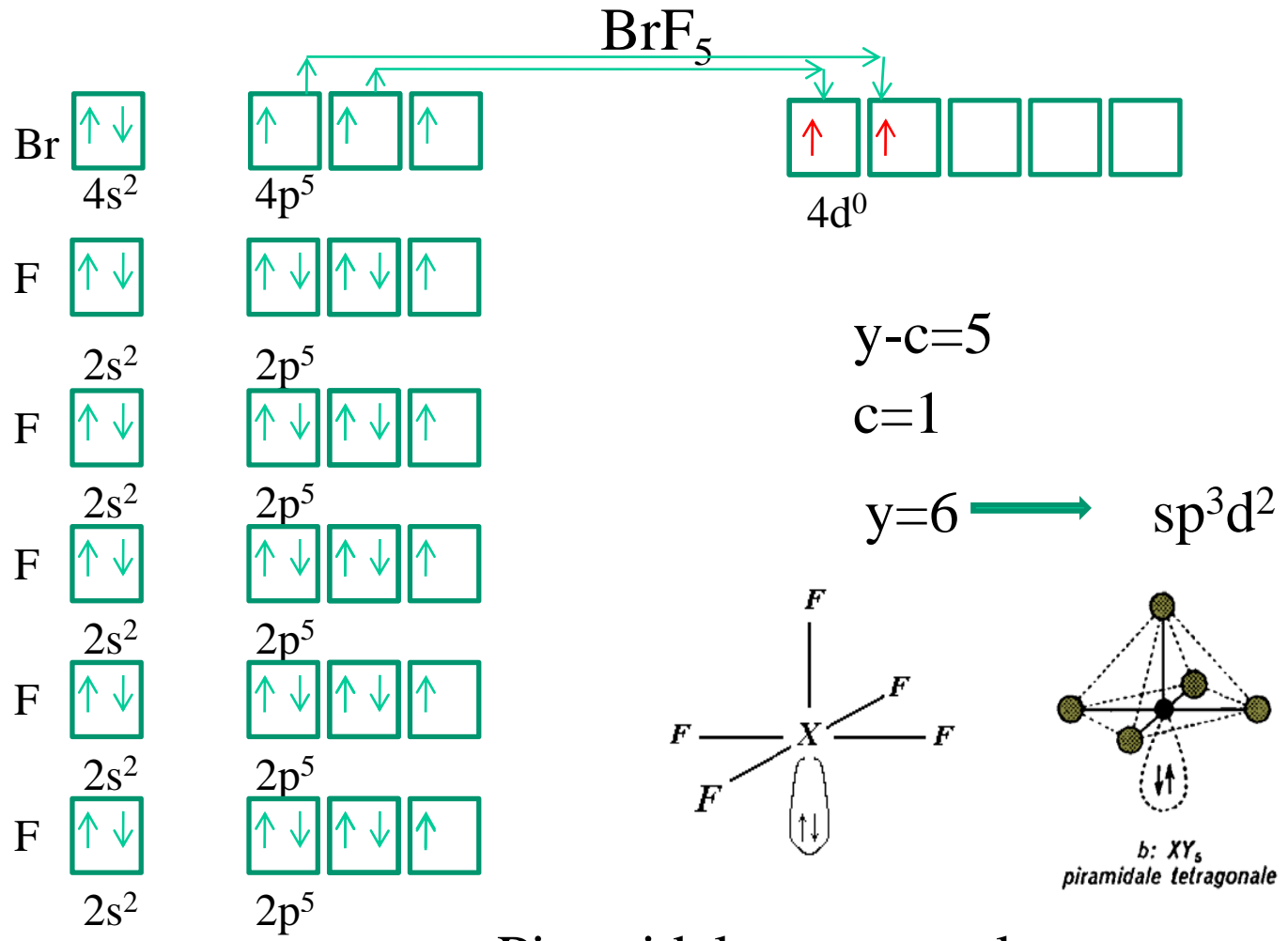

Piramidale tetragonale

c) molecole con l'atomo centrale ibridizzato  $sp^3d^2$ ,  
a geometria a **quadrata**

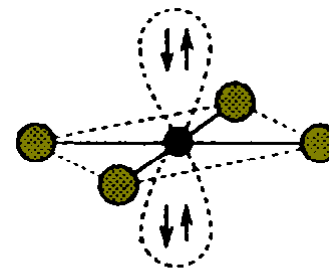
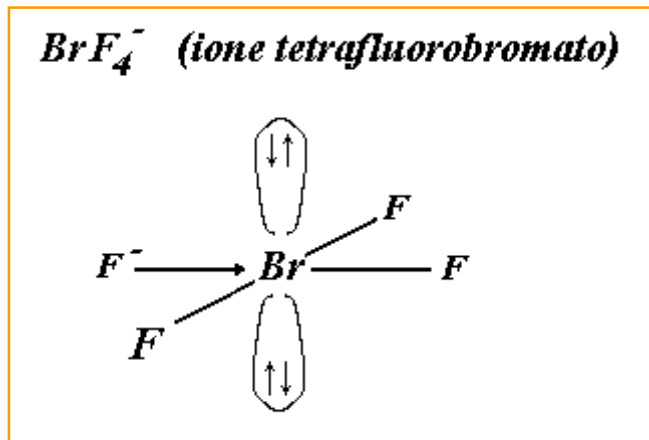

c:  $XY_4$   
quadrata piana

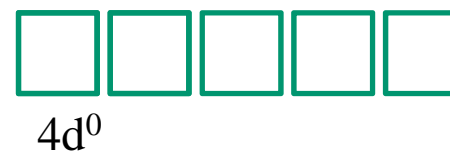
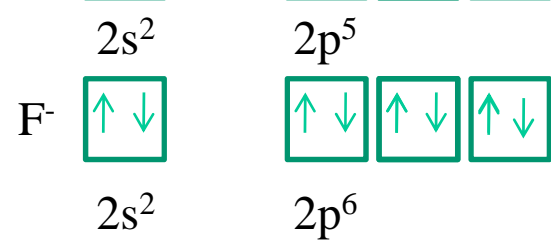
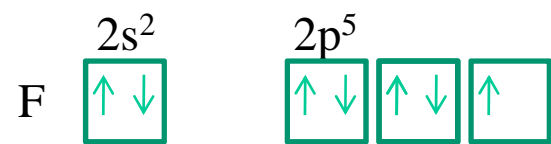
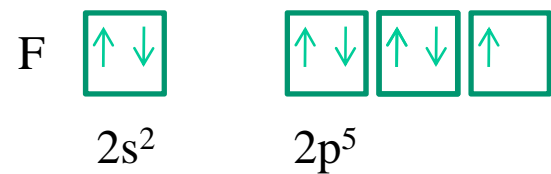

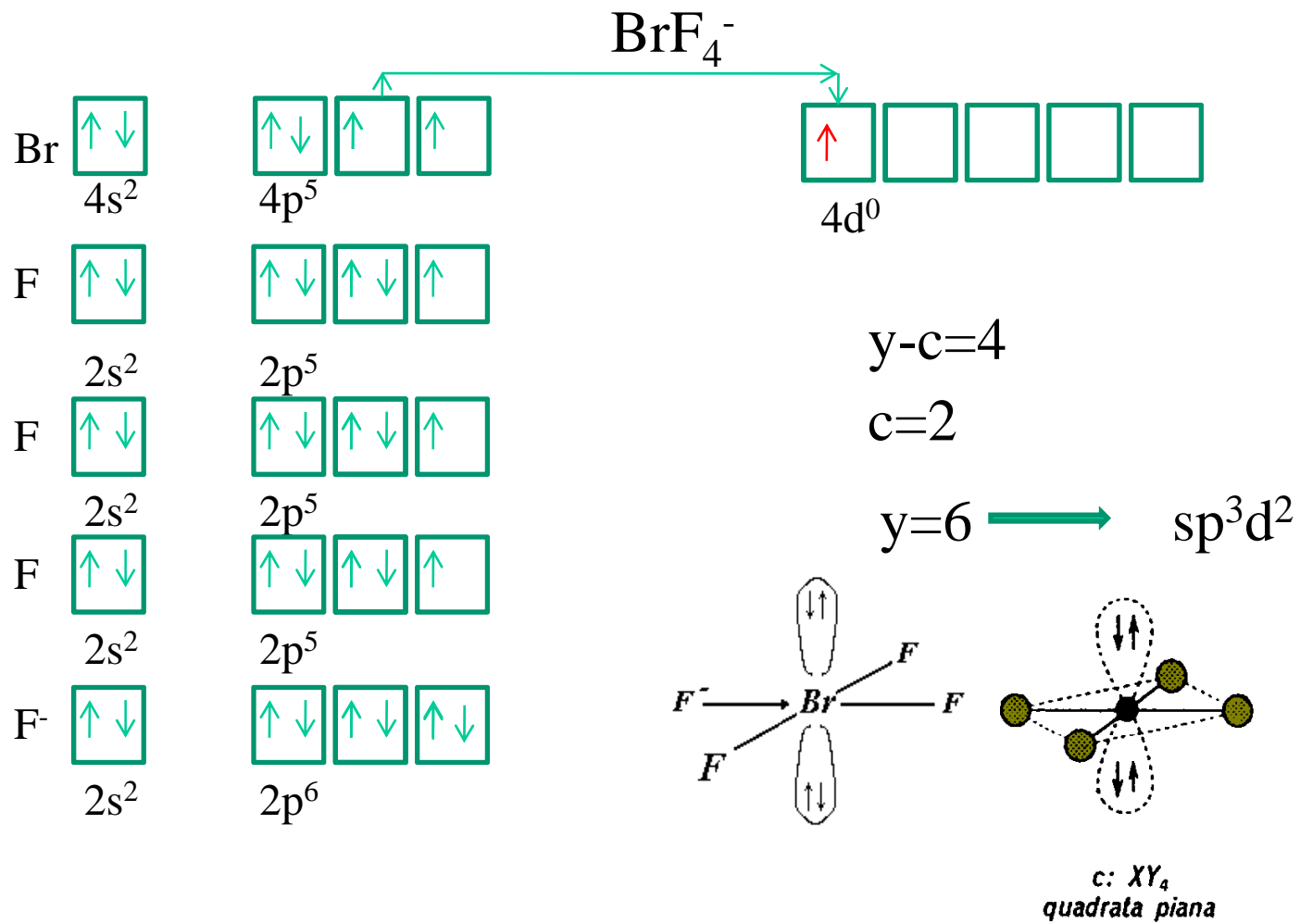

Quadrata piana